

2404  
2408

**CONTROL SETPOINT  
PROGRAMMER**



invensys  
**EUROTHERM**



**Installation and operation  
handbook**

# MODELS 2408 and 2404 PID CONTROLLERS

## INSTALLATION AND OPERATION HANDBOOK

<b>Contents</b>	<b>Page</b>
<b>Chapter 1</b>	<b>INSTALLATION ..... 1-1</b>
<b>Chapter 2</b>	<b>OPERATION ..... 2-1</b>
<b>Chapter 3</b>	<b>ACCESS LEVELS ..... 3-1</b>
<b>Chapter 4</b>	<b>TUNING ..... 4-1</b>
<b>Chapter 5</b>	<b>PROGRAMMER OPERATION ..... 5-1</b>
<b>Chapter 6</b>	<b>CONFIGURATION ..... 6-1</b>
<b>Chapter 7</b>	<b>USER CALIBRATION ..... 7-1</b>
<b>Appendix A</b>	<b>UNDERSTANDING THE ORDERING CODE ..... A-1</b>
<b>Appendix B</b>	<b>SAFETY and EMC INFORMATION..... B-1</b>
<b>Appendix C</b>	<b>TECHNICAL SPECIFICATION.....C-1</b>
<b>Appendix D</b>	<b>LOAD CURRENT MONITORING AND DIAGNOSTICS..D-1</b>
<b>Appendix E</b>	<b>PROFIBUS COMMUNICATIONS.....E-1</b>

“This product is covered by one or more of the following US Patents:

5,484,206; Additional patents pending.

PDS and INSTANT ACCURACY are trademarks of Eurotherm.”

**Issue 10 of this handbook applies to software version 4.**

## Enhancements to Software Version 4

The following enhancements have been added to software versions 4.

- Isolated Single Logic Output Module
- Transducer Power Supply Module to provide 5 or 10Vdc to an external transducer. (Not intended for melt pressure control)
- DeviceNet communications
- Linear over range limits are +5% of high instrument range and –5% of low instrument range for all process input ranges (i.e. 0-20mA, 4-20mA, 0-10V)
- Sensor break or input open circuit faults are detected on all analogue inputs (PV1.PV2 and remote input channels)
- PV2 alarm, full scale high and low limits default to maximum and minimum display limits
- Deviation alarms are not inverted when direct acting control is selected. Alarm behaviour when using reverse acting control is unchanged
- The PD track valve positioning parameter ( $Pd_{tr}$ ) has been removed

### Controllers Affected:-

Standard controllers – which include programmers with up to 4 programs	Version 4.11 or later
Setpoint programming controllers with up to 20 programs	Version 4.61 or later
Profibus controllers – which include programmers with up to 4 programs	Version 4.32 or later

- The 10Amp output relay in module 4 is not available on controllers supplied after Jan 04

### Related Information

- DeviceNet Communications Handbook part no. HA027506 which includes the parameter address map.
- Profibus Communications Handbook part no. HA026290
- EMC (Electromagnetic Compatibility) Installation Guide, part no. HA025464

These are available on [www.eurotherm.co.uk](http://www.eurotherm.co.uk).

# Chapter 1 INSTALLATION

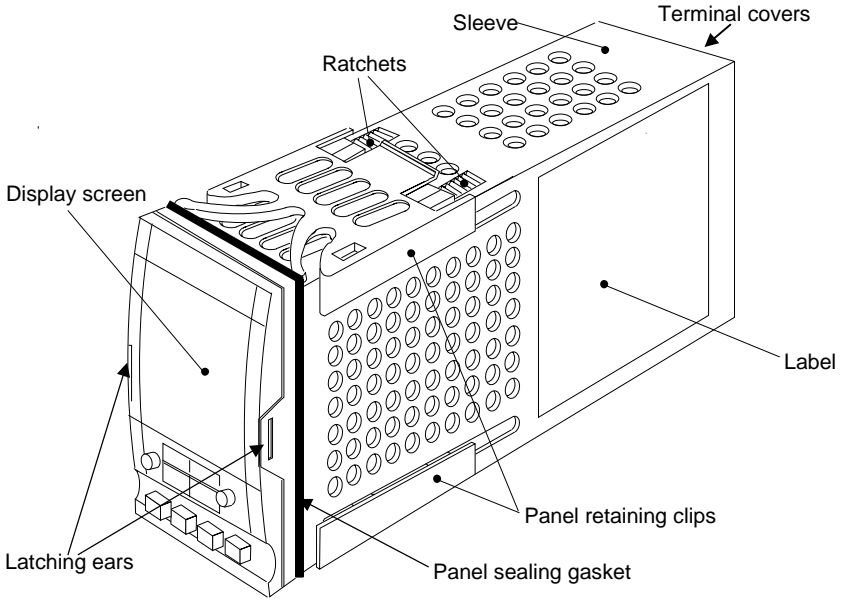

Figure 1-1 2408 1/8 DIN controller

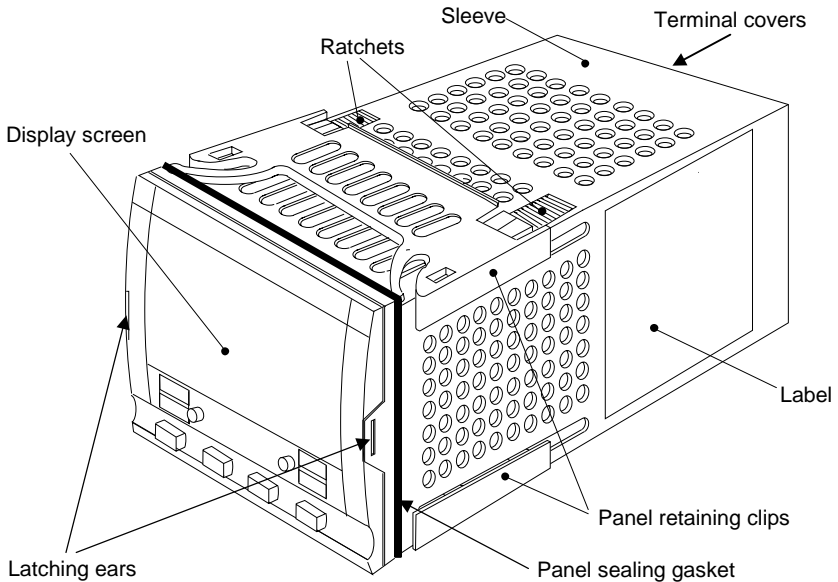

Figure 1-2 2404 1/4 DIN controller

**Outline dimensions Model 2408**

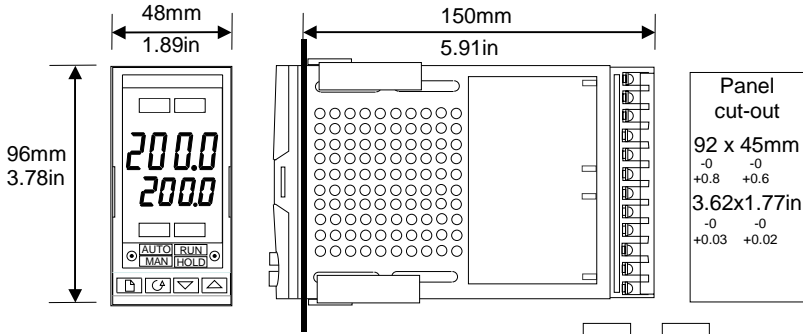
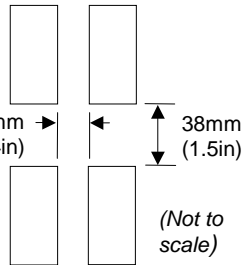

Figure 1-3  
Outline dimensions of Model 2408 controller



**Outline dimensions Model 2404**

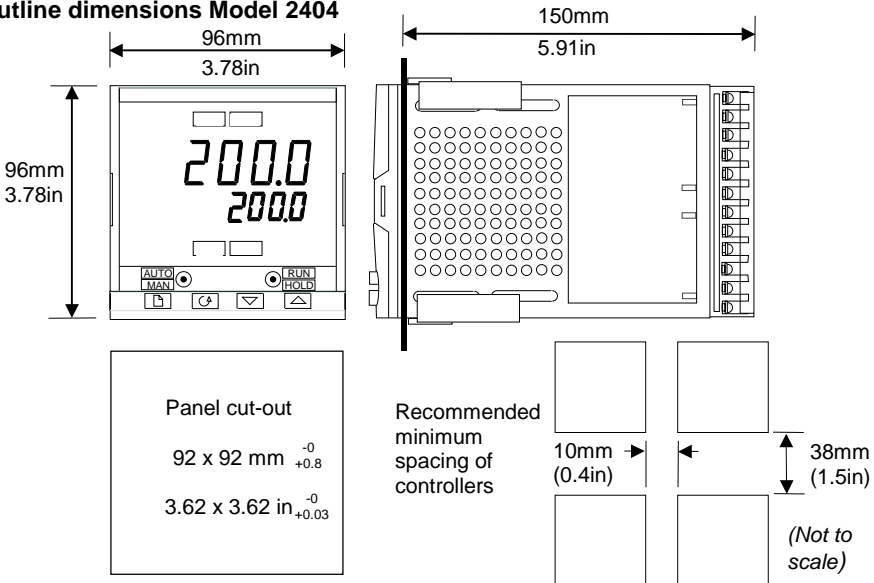

Figure 1-4 Outline dimensions Model 2404 controller

The electronic assembly of the controller plugs into a rigid plastic sleeve, which in turn fits into the standard DIN size panel cut-out shown in Figures 1-3 and 1-4.

## INTRODUCTION

Models 2408 and 2404 are high stability, temperature or process controllers with self and adaptive tuning. They have a modular hardware construction which accepts up to three plug-in Input/Output modules and two interface modules to satisfy a wide range of control requirements. Two digital inputs and an optional alarm relay are included as part of the fixed hardware build.

The instruments are available as:

- standard controllers - which include a basic 8-segment programmer  
Models 2408/CC and 2404/CC
- setpoint programming controllers: Models 2408/CP, P4, CM and  
2404/CP, P4, CM
- motorised valve controllers - which include a basic 8-segment programmer  
Models 2408/VC and 2404/VC
- setpoint programming motorised valve controllers: Models 2408/VP, V4, VM and  
2404/VP, V4, VM

**Before proceeding, please read the chapter called, *Safety and EMC Information*.**

### Controller labels

The labels on the sides of the controller identify the ordering code, the serial number, and the wiring connections.

Appendix A, *Understanding the Ordering Code*, explains the hardware and software configuration of your particular controller.

## MECHANICAL INSTALLATION

### To install the controller

1. Prepare the control panel cut-out to the size shown in Figure 1-3, or 1-4.
2. Insert the controller through the panel cut-out.
3. Spring the upper and lower panel retaining clips into place. Secure the controller in position by holding it level and pushing both retaining clips forward.

*Note:* If the panel retaining clips subsequently need removing, in order to extract the controller from the control panel, they can be unhooked from the side with either your fingers, or a screwdriver.

### Unplugging and plugging-in the controller

If required, the controller can be unplugged from its sleeve by easing the latching ears outwards and pulling it forward out of the sleeve. When plugging the controller back into its sleeve, ensure that the latching ears click into place in order to secure the IP65 sealing.

## NEW SLEEVE DESIGN MKIII

From Jan-03 an improved design of 1/8 DIN long sleeve is shipped with all new 2408 controllers and indicators. (The month and year of manufacture are shown in the last two pairs of digits of the instrument serial number).

### Details

A new sealing gasket will be fitted onto the instrument bezel ①. This gasket replaces the gasket which was moulded into the front of the sleeve of all previous instruments.

The gasket previously moulded into the sleeve where it fits behind the panel is now supplied as a separate item ②.

### Reasons for the Change

This change is to ensure that IP65 sealing is reliably achieved and less physical effort is required to insert the instrument into the new sleeve.

### Recommendations

1. An instrument delivered after Jan 03 should be used with the sleeve supplied
2. If the instrument is required to replace one already in use, the existing sleeve should also be replaced
3. A new instrument can be fitted into an existing sleeve by carefully removing gasket ① but IP65 sealing will not be maintained
4. An existing instrument can be fitted into a new sleeve but IP65 sealing will not be maintained

It is, however, possible to achieve IP65 sealing for 3 and 4 above. A gasket kit is available by quoting Part No SUB24/GAS2408.

Then:-

5. To fit a new instrument in an older sleeve carefully remove gasket ①. Replace it with the thinner (1.25mm) gasket from the kit
6. To fit an existing instrument into a new sleeve fit the thicker (1.6mm) gasket from the kit between the instrument and the sleeve

The seal ② supplied as a separate item with a new instrument, should be placed over the sleeve prior to mounting it through the panel cut out as shown below:-

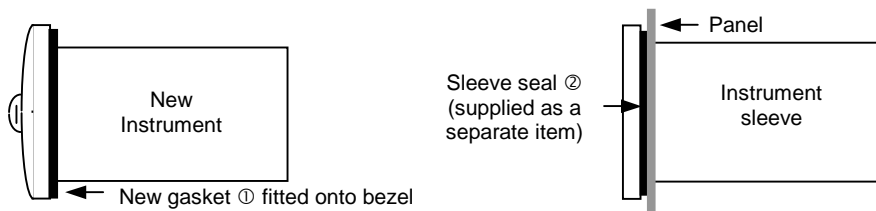

## ELECTRICAL INSTALLATION

This section consists of five topics:

- Rear terminal layouts
- Fixed connections
- Plug-in module connections
- Typical wiring diagrams
- Motorised valve connections.

### WARNING

**You must ensure that the controller is correctly configured for your application. Incorrect configuration could result in damage to the process being controlled, and/or personal injury. It is your responsibility, as the installer, to ensure that the configuration is correct. The controller may either have been configured when ordered, or may need configuring now. See Chapter 6, Configuration.**

### Model 2408 rear terminal layout

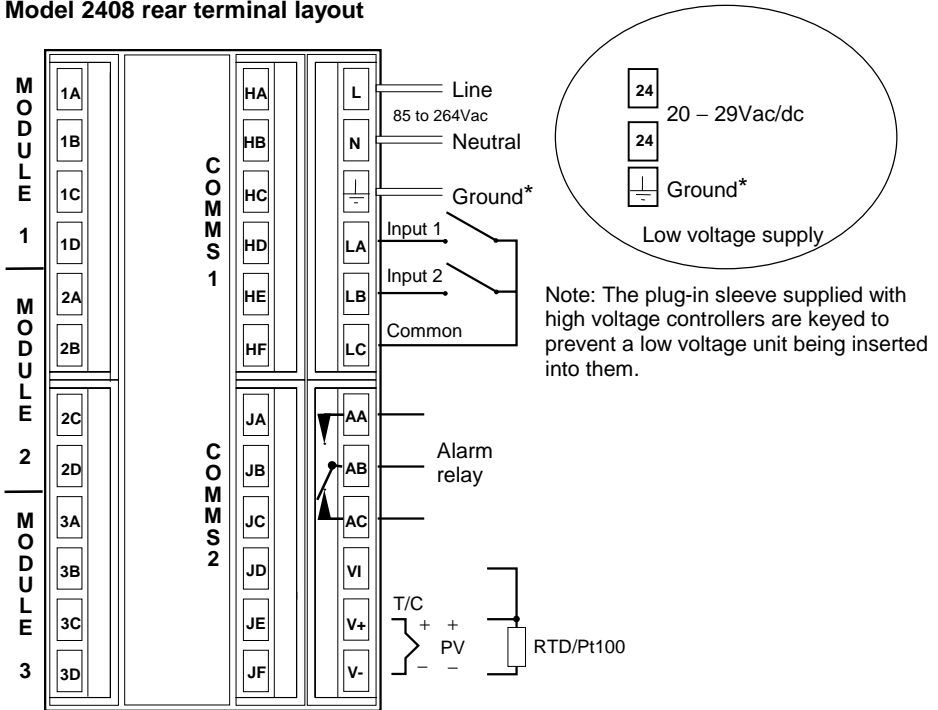

Figure 1-5 Rear terminal layout – Model 2408

\* The ground connection is provided as a return for internal EMC filters. It is not required for safety purposes, but must be connected in order to satisfy EMC requirements.



All electrical connections are made to the screw terminals at the rear of the controller. If you wish to use crimp connectors, the correct size is AMP part number 349262-1. They accept wire sizes from 0.5 to 1.5 mm<sup>2</sup> (16 to 22 AWG). The terminals are protected by a clear plastic hinged cover to prevent hands, or metal, making accidental contact with live wires.

**Rear terminal layouts**

The rear terminal layouts are shown in Figures 1-5 and 1-6. The right-hand column carries the connections to the power supply, digital inputs 1 and 2, alarm relay and sensor input. The second and third columns from the right carry the connections to the plug-in modules. The connections depend upon the type of module installed, if any. To determine which plug-in modules are fitted, refer to the ordering code and wiring data on the controller side labels.

**Model 2404 rear terminal layout**

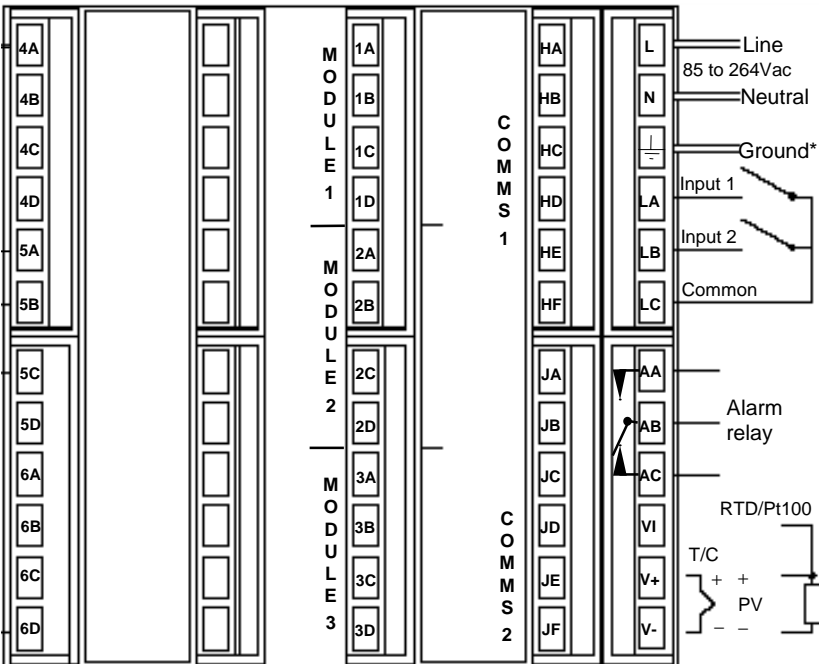
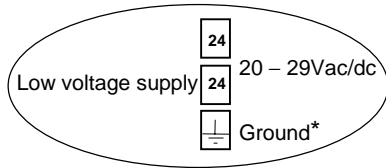

Figure 1-6 Rear terminal layout – Model 2404

## Sensor input connections

The connections for the various types of sensor input are shown below.

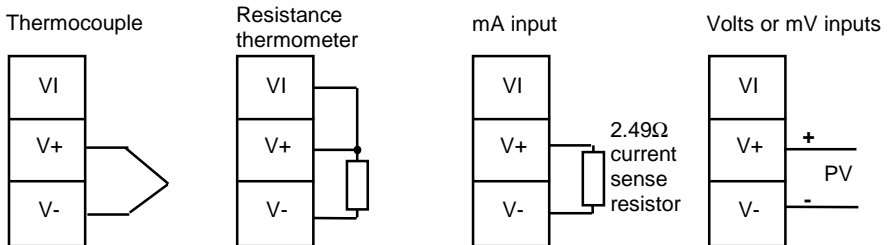

Fig 1-7 Sensor input connections

## PLUG-IN MODULE CONNECTIONS

### Module 1, 2 and 3

Module positions 1, 2 and 3 are plug-in modules. They can be either two terminal modules of the types shown in Figure 1-7, or four terminal modules of the types shown in Table 1-1.

The tables show the connections to each module and the functions that they can perform. Module 1 is normally used for heating and module 2 for cooling although the actual functions will depend upon how the controller has been configured.

### PDS modes

Table 1-8 refers to PDS modes 1 and 2.

PDS stands for 'Pulse Density Signalling' Input/Output. This is a proprietary technique for bi-directional transmission of analogue and digital data over a simple 2-wire connection.

PDS 1 mode uses a logic output module to control a TE10S solid state relay and provides a load failure alarm.

PDS 2 mode uses a logic output module to control a TE10S solid state relay, provide load/SSR failure alarms, and read back the load current for display on the controller.

## Two terminal modules

Note: Module 1 is connected to terminals 1A and 1B

Module 2 is connected to terminals 2A and 2B

Module 3 is connected to terminals 3A and 3B.



Module type	Terminal identity				Possible functions
	A	B	C	D	
Relay: 2-pin (2A, 264 Vac max.)			Unused		Heating, cooling, alarm, program event, valve raise, or valve lower
Logic - non-isolated (18Vdc at 20mA)			Unused		Heating, cooling, PDSIO mode 1, PDSIO mode 2, program event
Triac (1A, 30 to 264Vac)			Unused		Heating, cooling, program event, valve raise, or valve lower
DC output: - non-isolated (10Vdc, 20mA max.)			Unused		Heating, or cooling, or retransmission of PV, setpoint, or control output

Table 1-1 Two terminal module connections

## Snubbers

The relay and triac modules have an internal 15nF/100Ω 'snubber' connected across their output, which is used to prolong contact life and to suppress interference when switching inductive loads, such as mechanical contactors and solenoid valves.

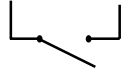
### WARNING

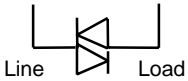
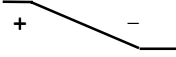
When the relay contact is open, or the triac is off, the snubber circuit passes 0.6mA at 110Vac and 1.2mA at 240Vac. You must ensure that this current, passing through the snubber, will not hold on low power electrical loads. It is your responsibility as the installer to ensure that this does not happen. If the snubber circuit is not required, it can be removed from the relay module (BUT NOT THE TRIAC) by breaking the PCB track that runs crosswise, adjacent to the edge connectors of the module. This can be done by inserting the blade of a small screwdriver into one of the two slots that bound it, and twisting.

**Four terminal modules**

Note: Module 1 is connected to terminals 1A, 1B, 1C and 1D  
 Module 2 is connected to terminals 2A, 2B, 2C and 2D  
 Module 3 is connected to terminals 3A, 3B, 3C and 3D

Module type	Terminal identity				Possible functions
	A	B	C	D	
Relay: changeover (2A, 264 Vac max.)					Heating, cooling, alarm, or program event output
DC control: Isolated (10V, 20mA max.)	+	-			Heating, or cooling
24Vdc transmitter supply	+	-			To power process inputs
Potentiometer input 100Ω to 15KΩ		+0.5Vdc		0V	Motorised Valve Position feedback
DC retransmission	+	-			Retrans. of setpoint, or process value
DC remote input or Process Value 2 (Module 3 only)	0-10Vdc	RT source	±100mV 0-20mA	COM	Remote Setpoint Second PV
<b>Dual output modules</b>					
Dual relay (2A, 264 Vac max.)					Heating + cooling Dual alarms Valve raise & lower
Dual Triac (1A, 30 to 264Vac)					Heating + cooling Valve raise & lower
Dual logic + relay (Logic is non-isolated)					Heating + cooling
Dual Logic + triac (Logic is non-isolated)					Heating + cooling
<b>Triple logic input and output modules - see ratings on the next page</b>					
Triple contact input	Input 1	Input 2	Input 3	Common	
Triple logic input	Input 1	Input 2	Input 3	Common	
Triple logic output	Output 1	Output 2	Output 3	Common	Program events

Module type	Terminal identity				Possible functions
	A	B	C	D	
Isolated Logic Output	+			-	This is a fully isolated module which can be fitted in all three module slots. It may be used for heating, cooling or events outputs up to 18Vdc at 20mA.
Transducer Power Supply	+	-			This provides fully isolated 5 or 10Vdc to power external transmitters up to 20mA. It can be fitted in module slots 1 and 2.

Table 1-2 Four terminal module connections

**Connections for Process Value 2 in module position 3**

The diagrams below show the connections for the various types of input. The input will have been configured in accordance with the ordering code.

Thermocouple

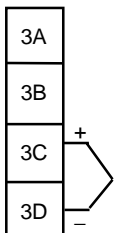

Resistance thermometer

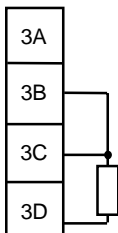

mA input

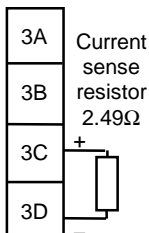

Volts or mV inputs

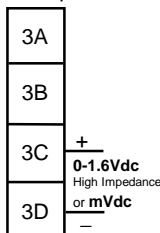

10V inputs

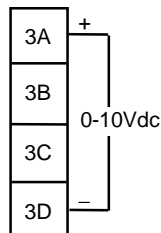

**Triple Logic Input and output ratings**

- Triple logic input (current sinking)
  - OFF state: -3 to 5Vdc
  - ON state: 10.8 to 30Vdc(max), at 2 to 8mA
- Triple contact closure or open collector transistor input
  - Internally generated switching Vdc & mA: 15 to 19Vdc at 10 to 14mA
  - OFF state >28KΩ input resistance
  - OFF state voltage >14Vdc
  - ON state <100Ω resistance
  - ON state voltage <1.0Vdc
- Triple logic output (current sourcing)
  - OFF state output 0 to 0.7Vdc.
  - ON state output 12 to 13Vdc, at up to 8mA.

## COMMUNICATION MODULES 1 AND 2

All 2408 and 2404 controllers can be fitted with up to two plug-in communications modules.

Only one of the two modules can be for serial communications and this will normally be installed in position COMMS 1 (although it is possible to install the serial communications module in position COMMS 2. Serial communications may be configured for either Modbus or EI bisynch protocol.

It is also possible to fit a PDS module in one or other of these positions.

Possible module types are shown in the table below.

Communications module 1	Terminal identity (COMMS 1)					
	HA	HB	HC	HD	HE	HF
2-wire EIA-485 serial communications	–	–	–	Common	A (+)	B (–)
EIA-232 serial communications	–	–	–	Common	Rx	Tx
4-wire EIA-485 serial communications	–	A' (Rx+)	B' (Rx–)	Common	A (Tx+)	B (Tx–)
PDS Setpoint retransmission	–	–	–	–	Signal	Common

Communications module 2	Terminal identity (COMMS 2)		
	JD	JE	JF
PDS Setpoint retransmission	–	Signal	Common
PDS Setpoint input	–	Signal	Common

Table 1-3 Communication modules 1 and 2 connections

**Wiring of 2-wire EIA-485 serial communications link**

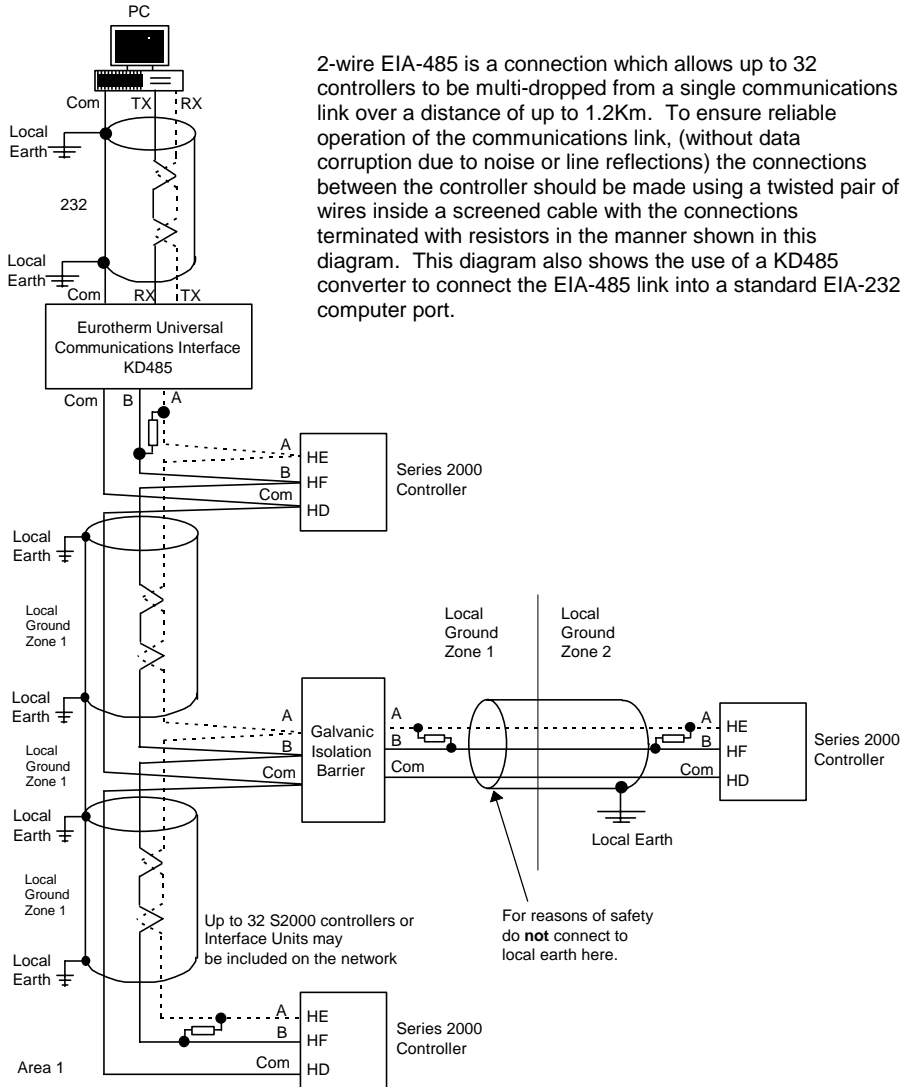

2-wire EIA-485 is a connection which allows up to 32 controllers to be multi-dropped from a single communications link over a distance of up to 1.2Km. To ensure reliable operation of the communications link, (without data corruption due to noise or line reflections) the connections between the controller should be made using a twisted pair of wires inside a screened cable with the connections terminated with resistors in the manner shown in this diagram. This diagram also shows the use of a KD485 converter to connect the EIA-485 link into a standard EIA-232 computer port.

**Note:**  
 All resistors are 220 ohm 1/4W carbon composition.  
 Local grounds are at equipotential. Where equipotential is not available wire into separate zones using a galvanic isolator.  
 Use a repeater (KD845) for more than 32 units.

Figure 1-9 EIA-485 wiring

## DeviceNet

Instruments fitted with software versions 4 onwards can be fitted with DeviceNet communications. The following shows the wiring connections for DeviceNet.

Terminal Reference	CAN Label	Color Chip	Description
HA	V+	Red	DeviceNet network power positive terminal. Connect the red wire of the DeviceNet cable here. If the DeviceNet network does not supply the power, connect to the positive terminal of an external 11-25 Vdc power supply.
HB	CAN_H	White	DeviceNet CAN_H data bus terminal. Connect the white wire of the DeviceNet cable here.
HC	SHIELD	None	Shield/Drain wire connection. Connect the DeviceNet cable shield here. To prevent ground loops, ground the DeviceNet network in only one location.
HD	CAN_L	Blue	DeviceNet CAN_L data bus terminal. Connect the blue wire of the DeviceNet cable here.
HE	V-	Black	DeviceNet network power negative terminal. Connect the black wire of the DeviceNet cable here. If the DeviceNet network does not supply the power, connect to the negative terminal of an external 11-25 Vdc power supply.
HF			Connect to instrument earth

Note: Power taps are recommended to connect the DC power supply to the DeviceNet trunk line. Power taps include:

- A Schottky Diode to connect the power supply V+ and allows for multiple power supplies to be connected.
- 2 fuses or circuit breakers to protect the bus from excessive current which could damage the cable and connectors.
- The earth connection, HF, to be connected to the main supply earth terminal.



### Example of Devicenet Wiring

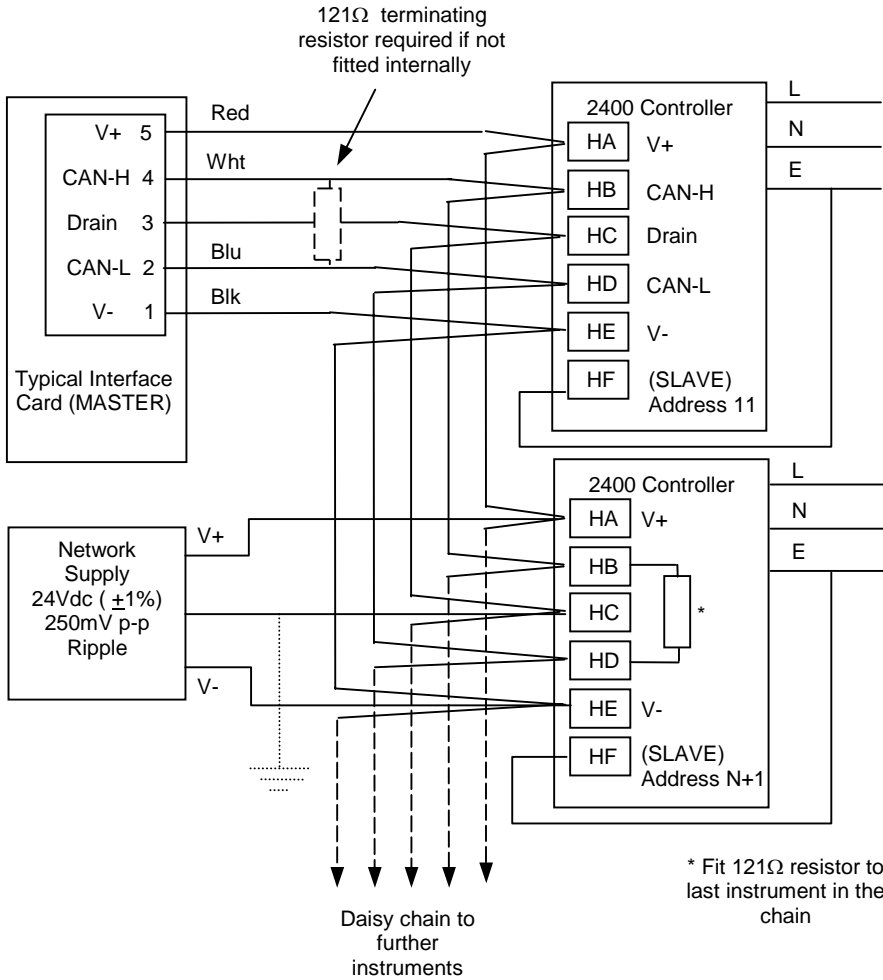

To configure DeviceNet Communications see Chapter 6.

### ProfiBus Wiring

Controllers supplied with model numbers 2408*f* and 2404*f* are fitted with ProfiBus communications modules fitted in the H slot. Further details of ProfiBus communications is given in Appendix E and the ProfiBus Communications handbook part number HA026290. This handbook can be downloaded from [www.eurotherm.co.uk](http://www.eurotherm.co.uk).

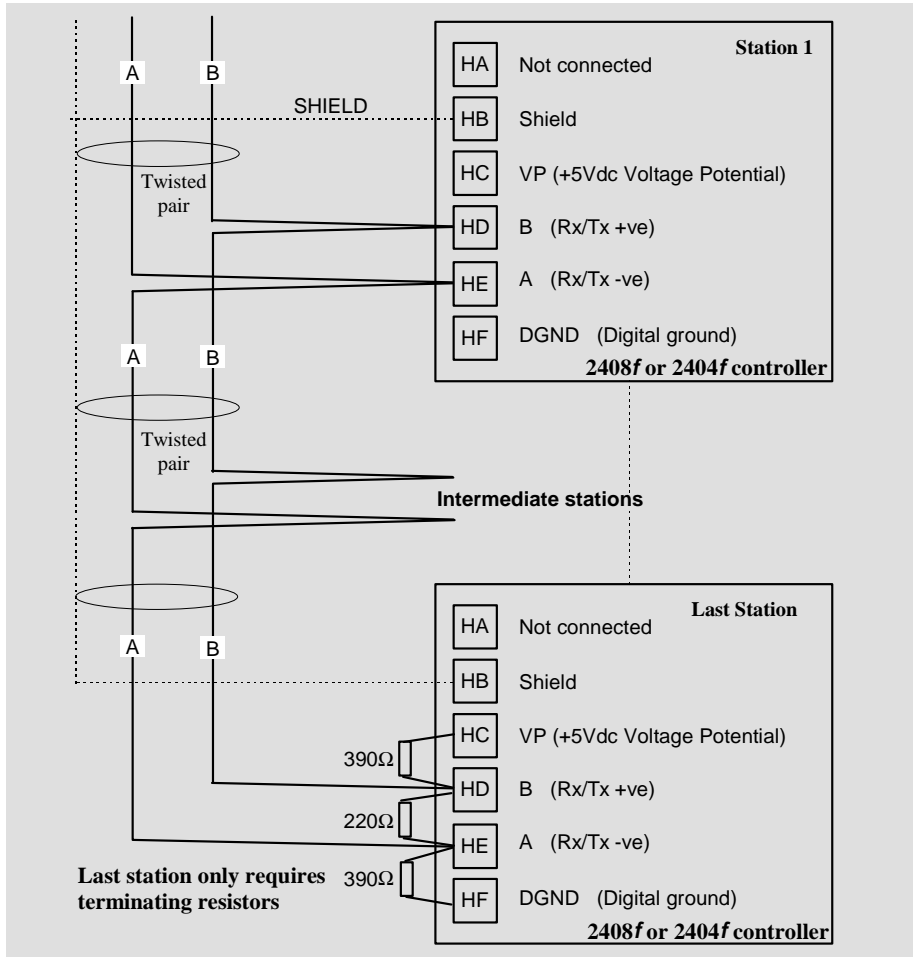

### TYPICAL WIRING DIAGRAM

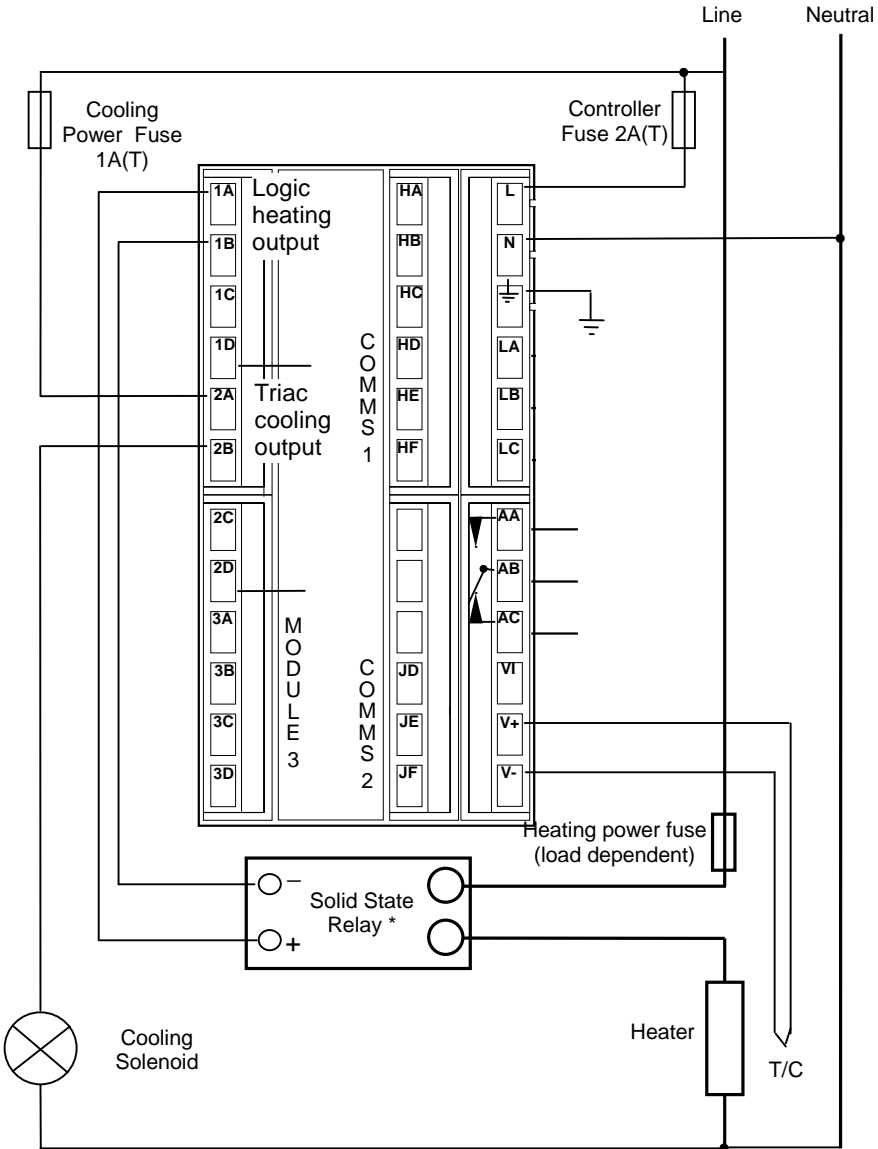

Fig 1-10 Typical wiring diagram, Model 2408 Controller

For logic drive capability see following chart:-

### Logic Drive Fan Out

The logic outputs from the 2400 series controllers are capable of driving more than one solid state relay (SSR) in series or parallel. The following table shows the number of SSRs which can be driven depending on type of SSR. S = Series; P = Parallel.

	Drive mA	SVDA	RVDA	TE10S	425S		
		Logic DC	Logic DC	Logic DC	Logic 10V	Logic 24V	Logic 20mA
Logic	18V@20	4S 6P	4S 3P	3S 2P	3S 3P	1S 2P	6S 1P
Triple logic	12V@9	3S 3P	2S 1P	2S 1P	2S 1P	1	4S 1P

	450			TC1027 CE	TE200S	TC2000 CE	RS3D A
	Standard	TTL	Multi-drive	Logic V	Logic DC	Logic DC	Logic DC
Logic	2S 3P	1S2P	6S 1P	3S 3P	3S 3P	3S 1P	4S 2P
Triple logic	1	1	4S 1P	2S 1P	2S 1P	0	0

### MOTORIZED VALVE CONNECTIONS

Motorised valves will normally be wired either to dual relay, or dual triac, output modules installed in the Module 1 position, or to single channel relay and triac outputs installed in Module positions 1 and 2. In the latter case, the convention is to configure output 1 as the raise output and output 2 as the lower output.

Depending on the configuration, control of the valve is achieved in one of three ways:

1. With no position feedback potentiometer.
2. With a feedback potentiometer used to monitor the valve's position. It does not influence the control.
3. With a feedback potentiometer, where the valve's position is controlled in response to the signal from it.

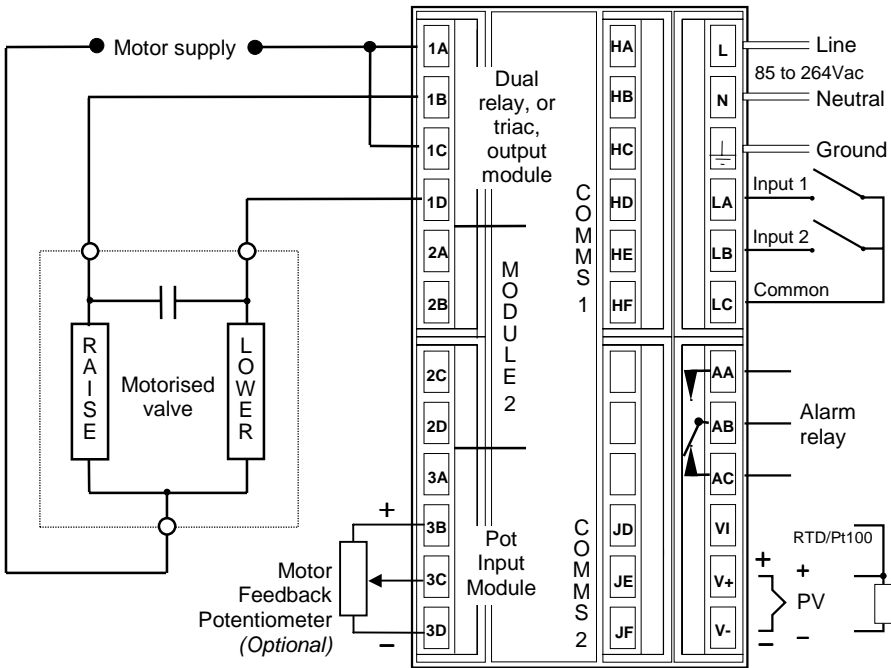

Fig 1-11 Motorised valve connections

## Chapter 2 OPERATION

This chapter has nine topics:

- FRONT PANEL LAYOUTS
- BASIC OPERATION
- OPERATING MODES
- AUTOMATIC MODE
- MANUAL MODE
- PARAMETERS AND HOW TO ACCESS THEM
- NAVIGATION DIAGRAM
- PARAMETER TABLES
- ALARMS

### FRONT PANEL LAYOUTS

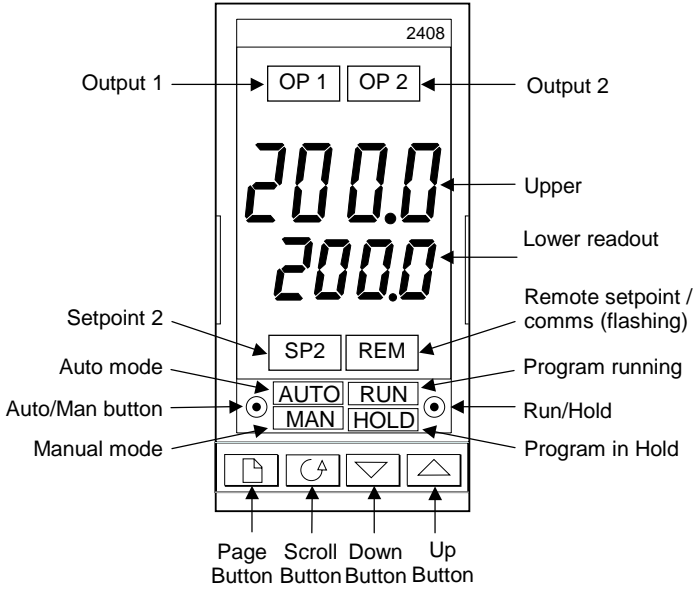

Figure 2-1 Model 2408 front panel layout

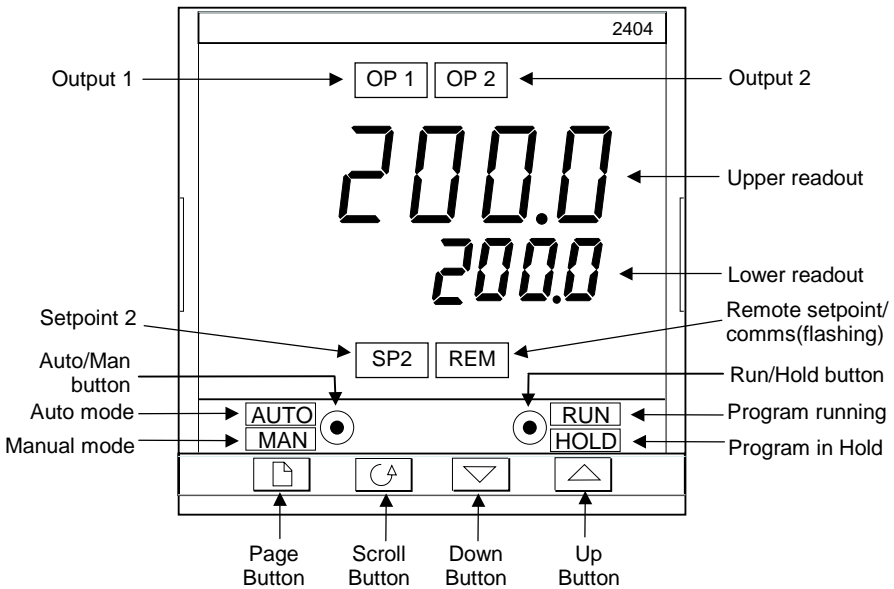

Figure 2-2 Model 2404 front panel layout







Button or indicator	Name	Explanation
OP1	Output 1	When lit, it indicates that the output installed in module position 1 is on. This is normally the heating output on a temperature controller.
OP2	Output 2	When lit, it indicates that the output installed in module position 2 is on. This is normally the cooling output on a temperature controller.
SP2	Setpoint 2	When lit, this indicates that setpoint 2, (or a setpoint 3-16) has been selected.
REM	Remote setpoint	When lit, this indicates that a remote setpoint input has been selected. 'REM' will also flash when communications is active.
	Auto/Manual button	When pressed, this toggles between automatic and manual mode: <ul style="list-style-type: none"> <li>• If the controller is in automatic mode the AUTO light will be lit.</li> <li>• If the controller is in manual mode, the MAN light will be lit.</li> </ul> The Auto/Manual button can be disabled in configuration level.
	Run/Hold button	<ul style="list-style-type: none"> <li>• Press once to start a program (RUN light on.)</li> <li>• Press again to hold a program (HOLD light on)</li> <li>• Press again to cancel hold and continue running (HOLD light off and RUN light ON)</li> <li>• Press and hold in for two seconds to reset a program (RUN and HOLD lights off)</li> </ul> The RUN light will flash at the end of a program. The HOLD light will flash during holdback or when a PDS retransmission output is open circuit.
	Page button	Press to select a new list of parameters.
	Scroll button	Press to select a new parameter in a list.
	Down button	Press to decrease a value in the lower readout.
	Up button	Press to increase a value in lower readout.

Figure 2-3 Controller buttons and indicators



## BASIC OPERATION

Switch on the power to the controller. It runs through a self-test sequence for about three seconds and then shows the measured temperature, or process value, in the upper readout and the target value, called the *setpoint*, in the lower readout. This is called the **Home** display.

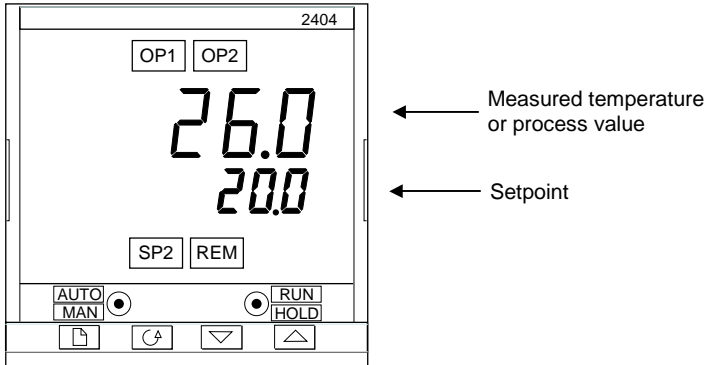





Figure 2-4 Home display

You can adjust the setpoint by pressing the  or  buttons. Two seconds after releasing either button, the display blinks to show that the controller has accepted the new value.

OP1 will light whenever output 1 is ON. This is normally the heating output when used as a temperature controller.

OP2 will light whenever output 2 is ON. This is normally the cooling output when used as a temperature controller.

**Note:** You can get back to this display at any time by pressing  and  together. Alternatively, you will always be returned to this display if no button is pressed for 45 seconds, or whenever the power is turned on.

## Alarms

If the controller detects an alarm condition, it flashes an alarm message in the Home display. For a list of all the alarm messages, their meaning and what to do about them, see *Alarms* at the end of this chapter.

## OPERATING MODES

The controller has two basic modes of operation:

- **Automatic mode** in which the output is automatically adjusted to maintain the temperature or process value at the setpoint.
- **Manual mode** in which you can adjust the output independently of the setpoint.

You toggle between the modes by pressing the AUTO/MAN button. The displays which appear in each of these modes are explained in this chapter.

Two other modes are also available:

- **Remote Setpoint mode**, in which the setpoint is generated from an external source. In this mode, the REM light will be on.
- **Programmer mode** which is explained in Chapter 5, *Programmer Operation*.

### AUTOMATIC MODE

You will normally work with the controller in automatic mode. If the MAN light is on, press the AUTO/MAN button to select automatic mode. The AUTO light comes on.

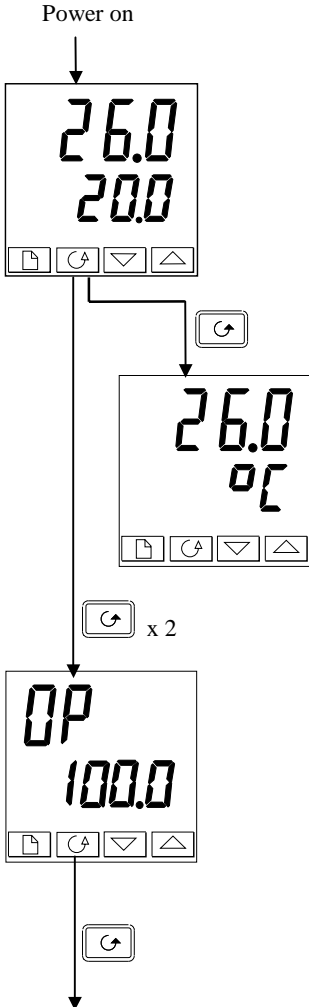

#### The Home display

Check that the AUTO light is on.  
 The upper readout shows the measured temperature.  
 The lower readout shows the setpoint.  
 To adjust the setpoint up or down, press ▲ or ▼.  
 (Note: If Setpoint Rate Limit has been enabled, then the lower readout will show the active setpoint. If ▲ or ▼ is pressed, it will change to show and allow adjustment of, the target setpoint.)

Press once.

#### Display units

A single press of will flash the display units for 0.5 seconds, after which you will be returned to the **Home** display.  
 Flashing of the display units may have been disabled in configuration in which case a single press will take you straight to the display shown below.

Press twice

#### % Output power demand

The % output power demand is displayed in the lower readout. This is a read-only value. You cannot adjust it.  
 Press and together to return to the **Home** display.

Press

Pressing from the Output Power display may access further parameters. These may be in this scroll list if the 'Promote' feature has been used (see Chapter 3, *Edit Level*). When you reach the end of this scroll list, pressing will return you to the **Home** display.

## MANUAL MODE

If the AUTO light is on, press the AUTO/MAN button to select manual mode. The MAN light comes on.

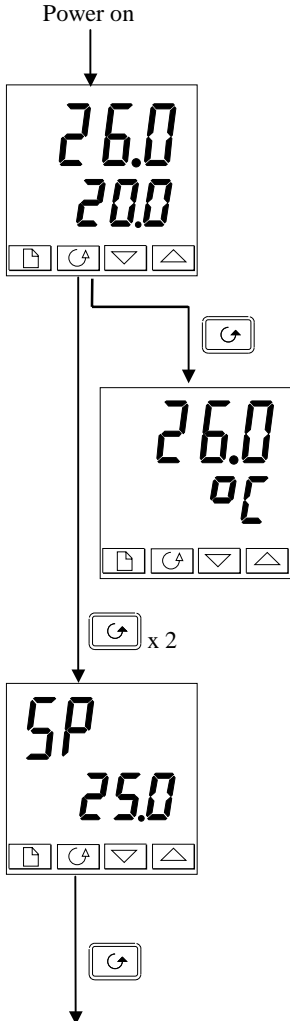

### The Home display

Check that the MAN light is on.

The upper readout shows the measured temperature, or process value. The lower readout shows the % output.

To adjust the output, press or .

*(Note: If Output Rate Limit has been enabled, then the lower readout will show the working output. If or is pressed, it will change to show and allow adjustment of, the target output.)*

Press once.

### Display units

A single press of flashes the display units for 0.5 seconds, after which you are returned to the Home display. Flashing of the display units may have been disabled in configuration, in which case a single press will take you straight to the display shown below.

Press twice.

### Setpoint

To adjust the setpoint value, press or .

Press .

Pressing from the Output Power display may access further parameters. These may be in this scroll list if the 'Promote' feature has been used (see Chapter 3, *Edit Level*). When you reach the end of this scroll list, pressing will return you to the **Home** display.

## PARAMETERS AND HOW TO ACCESS THEM

Parameters are settings, within the controller, that determine how the controller will operate. For example, alarm setpoints are parameters that set the points at which alarms will occur. For ease of access, the parameters are arranged in lists as shown in the navigation diagram on Pages 2-10 and 2-11. The lists are:

*Home list*

*Run list*

*Programming list*

*Alarm list*

*Autotune list*

*PID list*

*Motor list*

*Setpoint list*

*Input list*

*Output list*

*Communications list*

*Information list*

*Access list.*

Each list has a 'List Header' display.

### List header displays

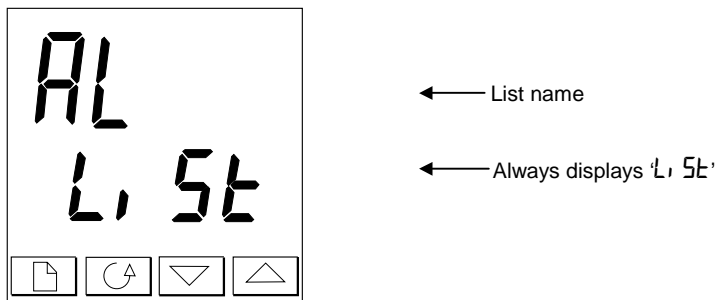

Figure 2-5 Typical list header display

A list header can be recognised by the fact that it always shows 'L, 5t' in the lower readout. The upper readout is the name of the list. In the above example, 'AL' indicates that it is the Alarm list header. List header displays are read-only.

**To step through the list headers**, press . Depending upon how your controller has been configured, a single press may momentarily flash the display units. If this is the case, a double press will be necessary to take you to the first list header. Keep pressing to step through the list headers, eventually returning you to the Home display.

**To step through the parameters within a particular list**, press .

When you reach the end of the list, you will return to the list header.

From within a list you can return to the current list header at any time can by pressing .

To step to the next list header, press once again.

## Parameter names

In the navigation diagram, each box shows the display for a selected parameter. The Operator parameter tables, later in this chapter, list all the parameter names and their meanings.

The navigation diagram shows all the parameters that can, *potentially*, be present in the controller. In practice, a limited number of them appear, as a result of the particular configuration.

The shaded boxes in the diagram indicate parameters that are hidden in normal operation. To view all the available parameters, you must select Full access level. For more information about this, see Chapter 3, *Access Levels*.

## Parameter displays

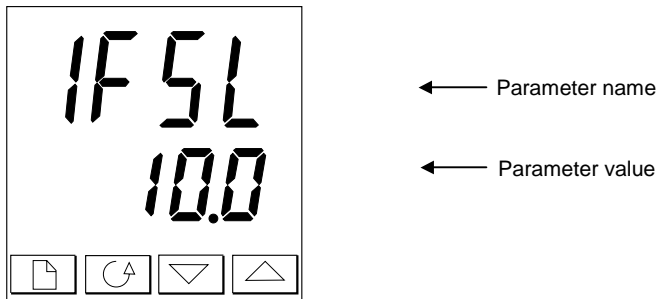



Figure 2-6 Typical parameter display

Parameter displays show the controller's current settings. The layout of parameter displays is always the same: the upper readout shows the parameter name and the lower readout its value. In the above example, the parameter name is *IFSL* (indicating *Alarm 1, full scale low*), and the parameter value is *10.0*.

### To change the value of a parameter

First, select the required parameter.

To change the value, press either  or . During adjustment, single presses change the value by one digit.

Keeping the button pressed speeds up the rate of change.

Two seconds after releasing either button, the display blinks to show that the controller has accepted the new value.

**NAVIGATION DIAGRAM (PART A)** (The parameters that appear depend upon how the controller has been configured)

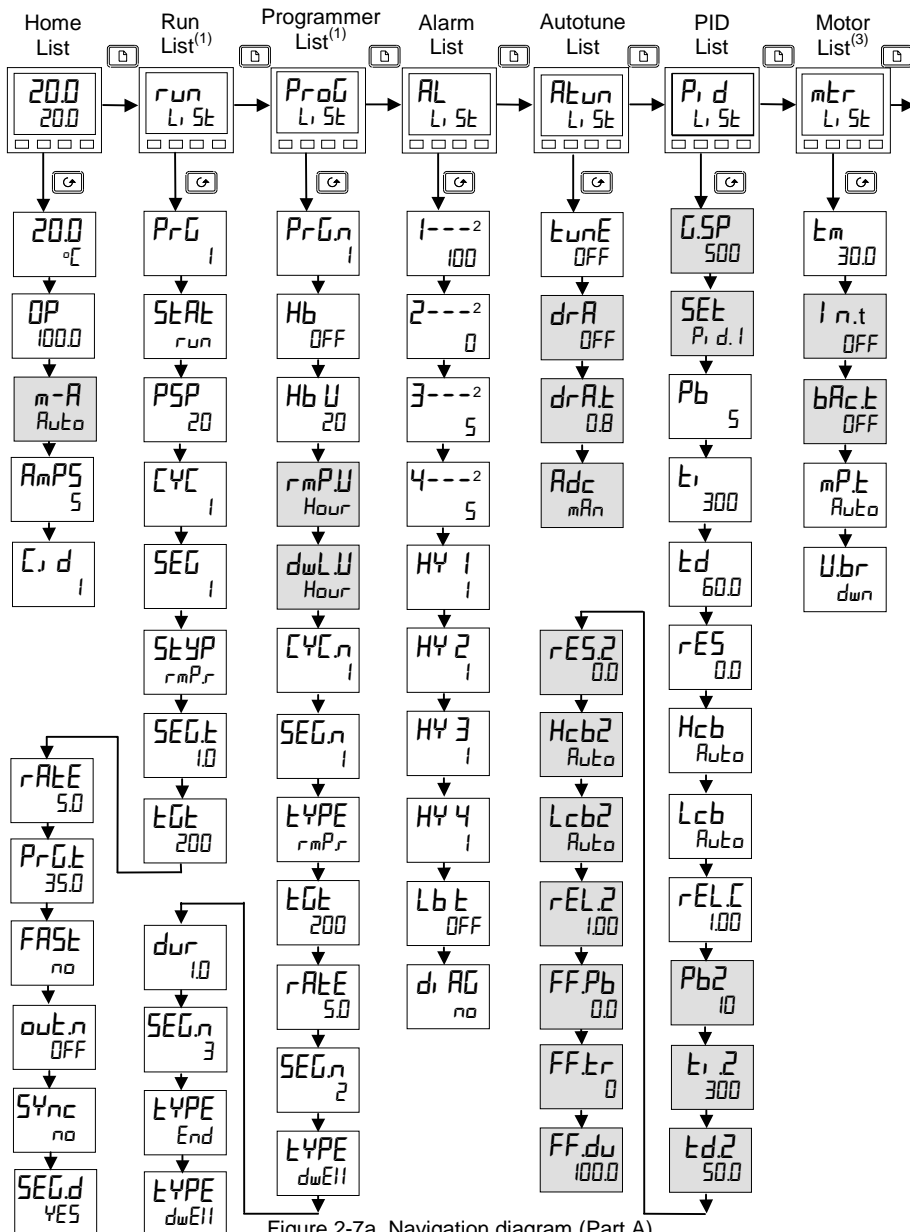

Figure 2-7a Navigation diagram (Part A)

### NAVIGATION DIAGRAM (PART B)

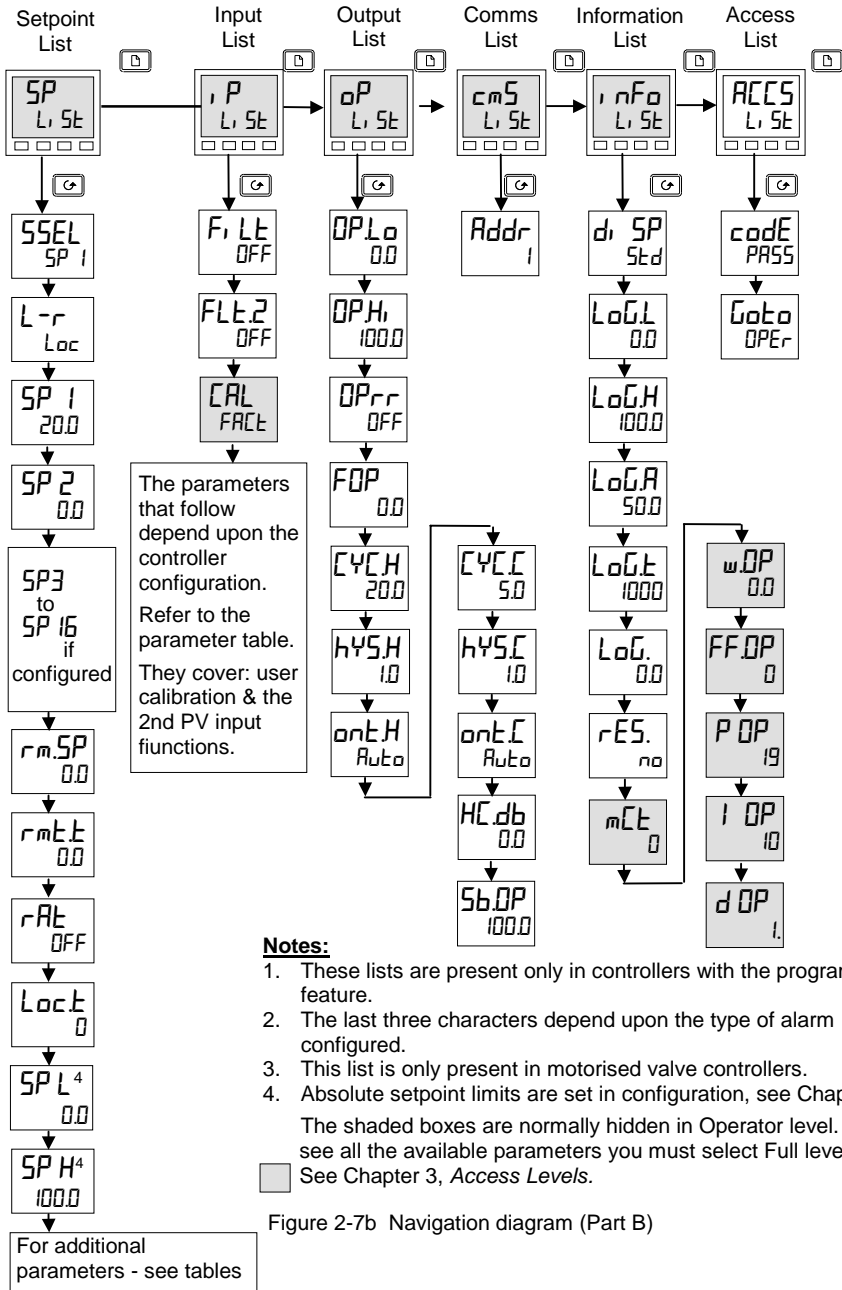

Figure 2-7b Navigation diagram (Part B)



## PARAMETER TABLES

Name	Description
------	-------------

Home list	
Home	Measured value and Setpoint
<b>OP</b>	% Output level
<b>SP</b>	Target setpoint (if in Manual mode )
<b>m-A</b>	Auto-man select
<b>AmPS</b>	Heater current (With PDSIO mode 2)
<b>C, d</b>	Customer defined identification number
+ Extra parameters, if the 'Promote' feature has been used (see Chapter 3, <i>Edit Level</i> ).	

Program run list – Present only in setpoint programming controllers	
<b>PrG</b>	Active program number (Only on 4, or 20, program versions)
<b>Stat</b>	Program status ( <i>OFF, run, hold, HbAc, End</i> )
<b>PSP</b>	Programmer setpoint
<b>CYC</b>	Number of cycles remaining in the program
<b>SEG</b>	Active segment number
<b>SEYP</b>	Active segment type
<b>SEgt</b>	Segment time remaining in the segment units
<b>tGt</b>	Target setpoint
<b>rAtE</b>	Ramp rate (if a rate segment)
<b>PrGt</b>	Program time remaining in hours
<b>FRSt</b>	Fast run through program ( <i>no / YES</i> )
<b>outn</b>	Event output states ( <i>OFF / on</i> ) ( <i>not 8-segment programmer</i> )
<b>SYnc</b>	Segment synchronisation ( <i>no / YES</i> ) ( <i>not 8-segment programmer</i> )
<b>SEEd</b>	Flash active segment type in the lower readout of the home display ( <i>no / YES</i> )

Name	Description
------	-------------

<b>Prog</b>	<b>Program edit list</b> – Present only in setpoint programming controller. For a fuller explanation of these parameters refer to Chapter 5						
<b>PrGn</b>	Select program number (Only on 4, or 20, program versions)						
<b>Hb</b>	Holdback type for the program as a whole (if configured)(OFF, Lo, Hi, or bAnd)						
<b>HbU</b>	Holdback value (in display units)						
<b>rmpU</b>	Ramp units (SEC, min, or Hour) [for both rmpR and rmpT type segments]						
<b>dwLU</b>	Dwell units (SEC, min, or Hour)						
<b>CYCL</b>	Number of program cycles (1 to 999, or 'cont')						
<b>SEGn</b>	Segment number						
<b>TYPE</b>	Segment type:(End) (rmpR=ramp rate) (rmpT=ramp time) (dwell) (STEP) (cALL)						
<i>The following parameters depend on the TYPE selected, as shown below.</i>							
	End	rmpR	rmpT	dwell	STEP	cALL	
<b>Hb</b>							Holdback type: OFF, Lo, Hi, or bAnd
<b>tgt</b>		✓	✓		✓		Target setpoint for a 'rmpR' or 'STEP' segment
<b>rRtE</b>		✓					Ramp rate for a 'rmpR' segment
<b>dur</b>			✓	✓			'dwell' time / Time to target for a 'rmpT' segment
<b>PrGn</b>						✓	cALLed Program number
<b>cYCL</b>						✓	No. of cycles of cALLed program
<b>outn</b>	✓	✓	✓	✓	✓		Event output: OFF/on (not 8-segment programmer)
<b>SYnc</b>		✓	✓	✓	✓		Segment synchronisation: no/YES (not 8-seg progr)
<b>Endt</b>	✓						End of prog – dwell, rSEt, S OP
<b>Pwr</b>							Power level in end segment

Name	Description
------	-------------

<b>AL</b>	<b>Alarm list</b>
-----------	-------------------

<b>1---</b>	Alarm 1 setpoint value
<b>2---</b>	Alarm 2 setpoint value
<b>3---</b>	Alarm 3 setpoint value
<b>4---</b>	Alarm 4 setpoint value

*In place of dashes, the last three characters indicate the alarm type. See alarm types table:*

<b>HY 1</b>	Alarm 1 Hysteresis (display units)
<b>HY 2</b>	Alarm 2 Hysteresis (display units)
<b>HY 3</b>	Alarm 3 Hysteresis (display units)
<b>HY 4</b>	Alarm 4 Hysteresis (display units)
<b>Lb t</b>	Loop Break Time in minutes
<b>d, AG</b>	Enable Diagnostic alarms 'na' / 'YES'

<b>Alarm types table</b>	
--------------------------	--

<b>-FSL</b>	PV Full scale low alarm
<b>-FSH</b>	PV Full scale high alarm
<b>-dEu</b>	PV Deviation band alarm
<b>-dHi</b>	PV Deviation high alarm
<b>-dLo</b>	PV Deviation low alarm
<b>-LCr</b>	Load Current low alarm
<b>-HCr</b>	Load Current high alarm
<b>-FL2</b>	Input 2 Full Scale low alarm
<b>-FH2</b>	Input 2 Full Scale high alarm
<b>-LOP</b>	Working Output low alarm
<b>-HOP</b>	Working Output high alarm
<b>-LSP</b>	Working Setpoint low alarm
<b>-HSP</b>	Working Setpoint high alarm
<b>4-rAL</b>	Rate of change alarm (AL 4 only)

<b>ALun</b>	<b>Autotune list</b>
-------------	----------------------

<b>FunE</b>	One-shot autotune enable
<b>drA</b>	Adaptive tune enable
<b>drAL</b>	Adaptive tune trigger level in display units. Range = 1 to 9999
<b>Adc</b>	Automatic Droop Compensation (PD control only)

Name	Description
------	-------------

<b>P, d</b>	<b>PID list</b>
-------------	-----------------

<b>GSP</b>	If Gain Scheduling has been enabled (see Chapter 4), this parameter sets the PV below which 'P, d, I' is active and above which 'P, d, I' or 'P, d, I' is active.
------------	---

<b>SEt</b>	'P, d, I' or 'P, d, I' selected
------------	---------------------------------

<b>Pb</b>	Proportional Band (SEt 1) (in display units)
<b>t<sub>i</sub></b>	Integral Time in secs (SEt 1)
<b>t<sub>d</sub></b>	Derivative Time in secs (SEt 1)
<b>rES</b>	Manual Reset (%) (SEt 1)
<b>Hcb</b>	Cutback High (SEt 1)
<b>Lcb</b>	Cutback Low (SEt 1)
<b>rEL1</b>	Relative Cool Gain (SEt 1)
<b>Pb2</b>	Proportional Band (SEt 2)
<b>t<sub>i</sub> 2</b>	Integral Time in secs (SEt 2)
<b>t<sub>d</sub> 2</b>	Derivative Time in secs (SEt 2)
<b>rES2</b>	Manual Reset (%) (SEt 2)
<b>Hcb2</b>	Cutback High (SEt 2)
<b>Lcb2</b>	Cutback Low (SEt 2)
<b>rEL2</b>	Relative Cool Gain (SEt 2)

*The following three parameters are used for cascade control. If this facility is not being used, then they can be ignored.*

<b>FFPb</b>	SP, or PV, feedforward propband
<b>FFtr</b>	Feedforward trim %
<b>FFdu</b>	PID feedforward limits ± %

<b>mtr</b>	<b>Motor list - see Table 4-3</b>
------------	-----------------------------------

<b>t<sub>m</sub></b>	Valve travel time in seconds
<b>I n.t</b>	Valve inertia time in secs
<b>bAclt</b>	Valve backlash time in secs
<b>mPt</b>	Minimum ON time of output pulse
<b>Ubr</b>	Valve sensor break strategy

Name	Description
------	-------------

SP	Setpoint list
SSEL	Select SP 1 to SP 16, depending on configuration
L-r	Local (Loc) or remote (rnt) setpoint select
SP 1	Setpoint one value
SP 2	Setpoint two value
rntSP	Remote setpoint value
rntt	Remote setpoint trim
rRt	Ratio setpoint
Loct	Local setpoint trim
SP L	Setpoint 1 low limit
SP H	Setpoint 1 high limit
SP2L	Setpoint 2 low limit
SP2H	Setpoint 2 high limit
SPrr	Setpoint Rate Limit
Hbty	Holdback Type for setpoint rate limit (OFF, Lo, Hi, or bAnd)
Hb	Holdback Value for setpoint rate limit in display units. (Hbty ≠ OFF)

, P	Input list
F, Lt	IP1 filter time constant (0.0 - 999.9 seconds).
FLE2	IP2 filter time constant (0.0 - 999.9 seconds).
Hi, JP Lo, JP	Transition of control between , P, 1 and , P, 2. (if configured) The transition region is set by the values of 'Lo, JP' and 'Hi, JP'. PV = , P, 1 below 'Lo, JP' PV = , P, 2 above 'Hi, JP'
F, 1 F, 2	Derived function, (if configured) PV = (F, 1 x , P, 1) + (F, 2 x , P, 2). 'F, 1' and 'F, 2' are scalars with the range -9.99 to 10.00
PU, P	Selects 'P, 1' or 'P, 2'
Continued in next column	

Name	Description
------	-------------

, P	Input list - continued
<i>The next 3 parameters appear if User Calibration has been enabled. (Refer to Chapter 7.) By default they are hidden when in Operator level. To prevent unauthorised adjustment, we recommend that they are only made available in Full access level.</i>	
CAL	'FACT' - reinstates the factory calibration and disables User calibration. Next 2 parameters will not appear. 'USER' - reinstates any previously set User calibration. All parameters below now appear.
CALS	Selected calibration point - 'none', 'P 1L', 'P 1H', 'P 2L', 'P 2H'
Adj *	User calibration adjust, if CALS = 'P 1L', 'P 1H', 'P 2L', 'P 2H'
OFF.1	IP1 calibration offset
OFF.2	IP2 calibration offset
mU.1	IP1 measured value (at terminals)
mU.2	IP2 measured value (at terminals), if DC input in Module 3 position
CJC.1	IP1 cold junction temp. reading
CJC.2	IP2 cold junction temp. reading
L, 1	IP1 linearised value
L, 2	IP2 linearised value
PUSL	Shows the currently selected PV input - 'P, 1' or 'P, 2'

*\* Do not make adjustments using the Adj parameter unless you wish to change the controller calibration.*

Name	Description
------	-------------

oP	Output list
<i>Does not appear if Motorised Valve control configured.</i>	
oPLo	Low power limit (%)
oPHi	High power limit (%)
oPrr	Output Rate Limit (% per sec)
FOP	Forced output level (%)
CYCH	Heat cycle time (0.2S to 999.9S)
HYSH	Heat hysteresis (display units)
ontH	Heat output min. on-time (secs) Auto (0.05S), or 0.1 - 999.9S
CYCL	Cool cycle time (0.2S to 999.9S)
HYSL	Cool hysteresis (display units)
ontL	Cool output min. on-time (secs) Auto (0.05S), or 0.1 - 999.9S
HCdb	Heat/cool deadband (display units)
SbOP	Sensor Break Output Power (%)

cmS	Comms list
Addr	Communications Address

cmS	DeviceNet (additional parameters)
nwSt	Indicates network status
run	Network connected and operational
rdy	Network connected but not operational
OFFL	Network not connected

info	Information list
diSP	Configure lower readout of Home display to show: UPoS Valve position Std Standard - display setpoint AmPS Load current in amps OP Output StAt Program status PrGt Program time remaining in hours L <sub>2</sub> Process value 2 rAt Ratio setpoint PrG Selected program number rSP Remote setpoint
LoGL	PV minimum
LoGH	PV maximum
LoGR	PV mean value
LoGt	Time PV above Threshold level
LoGw	PV Threshold for Timer Log
<i>Continued in next column</i>	

Name	Description
------	-------------

info	Information list - continued
rESL	Logging Reset - 'YES/no'
<i>The following set of parameters is for diagnostic purposes.</i>	
wOP	Working output
FFOP	Feedforward component of output
UO	PID output to motorised valve



RCCS	Access List
codE	Access password
GoTo	Goto level - OPEr, FuLL, Ed, t or cOnF
COnF	Configuration password

## ALARMS

### Alarm annunciation

Alarms are flashed as messages in the Home display. A new alarm is displayed as a double flash followed by a pause, old (acknowledged) alarms as a single flash followed by a pause. If there is more than one alarm condition, the display cycles through all the relevant alarm messages. Table 2-1 and Table 2-2 list all of the possible alarm messages and their meanings.

### Alarm acknowledgement and resetting

Pressing both  and  at the same time will acknowledge any new alarms and reset any latched alarms.

### Alarm modes

Alarms will have been set up to operate in one of several modes, either:

- **Non-latching**, which means that the alarm will reset automatically when the Process Value is no longer in the alarm condition.
- **Latching**, which means that the alarm message will continue to flash even if the alarm condition no longer exists and will only clear when reset.
- **Blocking**, which means that the alarm will only become active after it has first entered a safe state on power-up.

### Alarm types

There are **two** types of alarm: **Process alarms** and **Diagnostic alarms**.

### Process alarms

These warn that there is a problem with the process which the controller is trying to control.

Alarm Display	What it means
<u>F</u> S <u>L</u> *	PV Full Scale Low alarm
<u>F</u> S <u>H</u> *	PV Full Scale High alarm
<u>d</u> E <u>u</u> *	PV Deviation Band alarm
<u>d</u> H <sub>1</sub> *	PV Deviation High alarm
<u>d</u> L <sub>o</sub> *	PV Deviation Low alarm
<u>L</u> C <u>r</u> *	Load Current Low alarm
<u>H</u> C <u>r</u> *	Load Current High alarm

Alarm Display	What it means
<u>F</u> L <sub>2</sub> *	Input 2 Full Scale Low alarm
<u>F</u> H <sub>2</sub> *	Input 2 Full Scale High alarm
<u>L</u> O <u>P</u> *	Working Output Low alarm
<u>H</u> O <u>P</u> *	Working Output High alarm
<u>L</u> S <u>P</u> *	Working Setpoint Low alarm
<u>H</u> S <u>P</u> *	Working Setpoint High alarm
<u>r</u> A <u>L</u>	PV Rate of change alarm <i>Always assigned to Alarm 4</i>

\* In place of the dash, the first character will indicate the alarm number.

Table 2-1 Process alarms

## Diagnostic alarms

These indicate that a fault exists in either the controller or the connected devices.

Display shows	What it means	What to do about it
<b>EEEr</b>	<i>Electrically Erasable Memory Error:</i> The value of an operator, or configuration, parameter has been corrupted.	This fault will automatically take you into Configuration level. Check all of the configuration parameters before returning to Operator level. Once in Operator level, check all of the operator parameters before resuming normal operation. If the fault persists, or occurs frequently, contact your supplier
<b>Sbr</b>	<i>Sensor Break:</i> Input sensor is unreliable or the input signal is out of range.	Check that the sensor is correctly connected.
<b>Lbr</b>	<i>Loop Break</i> The feedback loop is open circuit.	Check that the heating and cooling circuits are working properly.
<b>LdF</b>	<i>Load failure</i> Indication that there is a fault in the heating circuit or the solid state relay.	This is an alarm generated by feedback from a TE10S solid state relay (SSR) operating in PDSIO mode 1 - see Chapter 1, <i>Electrical Installation</i> . It indicates either an open or short circuit SSR, blown fuse, missing supply or open circuit heater.
<b>SSrF</b>	<i>Solid state relay failure</i> Indication that there is a fault in the solid state relay.	This is an alarm generated by feedback from a TE10S solid state relay (SSR) operating in PDSIO mode 2 - see Chapter 1, <i>Electrical Installation</i> . It indicates either an open or short circuit condition in the SSR.
<b>HrF</b>	<i>Heater failure</i> Indication that there is a fault in heating circuit.	This is an alarm generated by feedback from a TE10S solid state relay (SSR) operating in PDSIO mode 2 - see Chapter 1, <i>Electrical Installation</i> . It indicates either a blown fuse, missing supply, or open circuit heater.
<b>CTOP</b>	<u>C</u> urrent <u>T</u> ransformer <u>O</u> pen <u>C</u> ircuit	Indicates that the PDS input is open circuit. Mode 5 only
<b>CTSh</b>	<u>C</u> urrent <u>T</u> ransformer <u>S</u> hort <u>C</u> ircuit	Indicates that the PDS input is short circuit Mode 5 only
<b>HwEr</b>	<i>Hardware error</i> Indication that a module is of the wrong type, missing, or faulty.	Check that the correct modules are fitted.

<b>no I/O</b>	<i>No I/O</i> None of the expected I/O modules is fitted.	This error message normally occurs when pre-configuring a controller without installing any of the required I/O modules.
<b>rmIF</b>	<i>Remote input failure.</i> Either the PDSIO input, or the remote DC input, is open or short circuit	Check for open, or short circuit wiring on the PDSIO, or remote DC, input.
<b>LLLL</b>	<i>Out of range low reading</i>	Check the value of the input.
<b>HHHH</b>	<i>Out of range high reading</i>	Check the value of the input.
<b>Err1</b>	<i>Error 1: ROM self-test fail</i>	Return the controller for repair.
<b>Err2</b>	<i>Error 2: RAM self-test fail</i>	Return the controller for repair.
<b>Err3</b>	<i>Error 3: Watchdog fail</i>	Return the controller for repair.
<b>Err4</b>	<i>Error 4: Keyboard failure</i> Stuck button, or a button was pressed during power up.	Switch the power off and then on, without touching any of the controller buttons.
<b>Err5</b>	<i>Error 5: Faulty internal communications.</i>	Check printed circuit board interconnections. If the fault cannot be cleared, return the controller for repair.
<b>Err6</b>	Digital filter chip faulty or loose board inside controller	Return the controller for repair.
<b>Err7</b>	PV id failure/PSU failure	Return the controller for repair.
<b>Err8</b>	Module 1 id error	Faulty or loose module or may be isolation problem
<b>Err9</b>	Module 2 id error	Faulty or loose module or may be isolation problem
<b>ErrA</b>	Module 3 id error	Faulty or loose module or may be isolation problem
<b>dCF</b>	DC output fail	Return the controller for repair
<b>tUEr</b>	Tune error – shown If any one stage of the auto-tuning process exceeds two hours	Check response time of process: check that the sensor has not failed: check that the loop is not broken. Acknowledge by pressing 'page' key and 'scroll' key together
<b>Pbr</b>	Potentiometer break	Check that the feedback potentiometer is correctly connected or the pot is not open circuit

Table 2-2 Diagnostic alarms





## Chapter 3 ACCESS LEVELS

This chapter describes the different levels of access to the operating parameters within the controller.

There are three topics:

- THE DIFFERENT ACCESS LEVELS
- SELECTING AN ACCESS LEVEL
- EDIT LEVEL

### THE DIFFERENT ACCESS LEVELS

There are four access levels:

- **Operator level**, which you will normally use to operate the controller.
- **Full level**, which is used to commission the controller.
- **Edit level**, which is used to set up the parameters that you want an operator to be able to see and adjust when in Operator level.
- **Configuration level**, which is used to set up the fundamental characteristics of the controller.

Access level	Display shows	What you can do	Password Protection
Operator	<i>OPER</i>	In this level, operators can view and adjust the value of parameters defined in Edit level (see below).	No
Full	<i>FULL</i>	In this level, all the parameters relevant to a particular configuration are visible. All alterable parameters may be adjusted.	Yes
Edit	<i>EDIT</i>	In this level, you can determine which parameters an operator is able to view and adjust in Operator level. You can hide, or reveal, complete lists, individual parameters within each list and you can make parameters read-only or alterable. (See <i>Edit level</i> at the end of this chapter).	Yes
Configuration	<i>CONF</i>	This special level allows access to set up the fundamental characteristics of the controller.	Yes

Figure 3-1 Access levels

## SELECTING AN ACCESS LEVEL

Access to Full, Edit or Configuration levels is protected by a password to prevent unauthorised access.

If you need to change the password, see Chapter 6, *Configuration*.

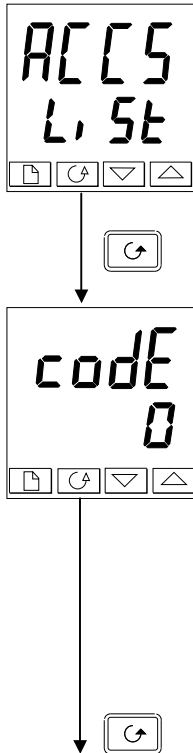

### Access list header

Press until you reach the access list header 'ACCESS'.

Press .

### Password entry

The password is entered from the 'code' display.

Enter the password using or . Once the correct password has been entered, there is a two second delay after which the lower readout will change to show 'PASS' indicating that access is now unlocked.

The pass number is set to '1' when the controller is shipped from the factory.

*Note;* A special case exists if the password has been set to '0'. In this case access will be permanently unlocked and the lower readout will always show 'PASS'.

Press to proceed to the 'Goto' page.

(If an *incorrect* password has been entered and the controller is still 'locked' then pressing returns you to the 'ACCESS' list header.)

### Access to Read-only Configuration

From this display, pressing and together will take you into Read-Only Configuration without entering a password. This will allow you to view all of the configuration parameters, but not adjust them. If no button is pressed for ten seconds, you will be returned to the Home display. Alternatively, pressing and together takes you immediately back to the Home display.

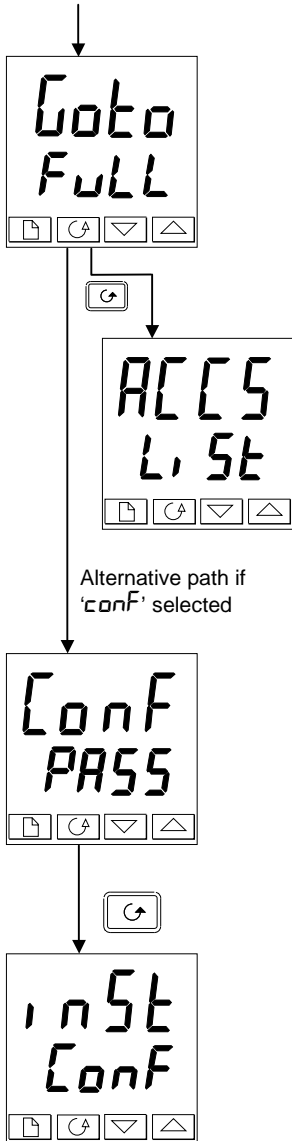

**Level selection**

The 'Goto' display allows you to select the required access level.

Use and to select from the following display codes:

- OPER*: Operator level
- FULL*: Full level
- Edit*: Edit level
- CONF*: Configuration level

Press

If you selected either '*OPER*', '*FULL*' or '*Edit*' level you will be returned to the '*ACCS*' list header in the level that you chose. If you selected '*CONF*', you will get a display showing '*CONF*' in the upper readout (see below).

**Configuration password**

When the '*CONF*' display appears, you must enter the Configuration password in order to gain access to this level. Do this by repeating the password entry procedure described in the previous section.

The configuration password is set to '2' when the controller is shipped from the factory. If you need to change the configuration password, see Chapter 6, *Configuration*.

Press

**Configuration level**

The first display of configuration is shown. See Chapter 6, *Configuration*, for details of the configuration parameters.

For instructions on leaving configuration level, see Chapter 6, *Configuration*.

**Returning to Operator Level**

To return to operator level from either '*FULL*' or '*Edit*' level, repeat entry of the password and select '*OPER*' on the 'Goto' display.



In '*Edit*' level, the controller will automatically return to operator level if no button is pressed for 45 seconds.

## EDIT LEVEL



Edit level is used to set which parameters you can view and adjust in Operator level. It also gives access to the 'Promote' feature, which allows you to select and add ('Promote') up to twelve parameters into the Home display list, thereby giving simple access to commonly used parameters.

### Setting operator access to a parameter

First you must select *Edit* level, as shown on the previous page.

Once in *Edit* level, you select a list, or a parameter within a list, in the same way as you would in Operator, or Full, level – that is to say, you move from list header to list header by pressing , and from parameter to parameter within each list using .

**However, in Edit level what is displayed is not the value of a selected parameter, but a code representing that parameter's availability in Operator level.**

When you have selected the required parameter, use  and  buttons to set its availability in Operator level.

There are four codes:

<b>ALtE</b>	Makes a parameter alterable in Operator level.
<b>PrO</b>	Promotes a parameter into the Home display list.
<b>rEAD</b>	Makes a parameter, or list header, read-only ( <i>it can be viewed but not altered</i> ).
<b>Hi dE</b>	Hides a parameter, or list header.

For example:

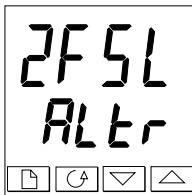

The parameter selected is Alarm 2, Full Scale Low

It will be alterable in Operator level

### Hiding or revealing a complete list

To hide a complete list of parameters, all you have to do is hide the list header. If a list header is selected, only two selections are available: *rEAD* and *Hi dE*.

(It is not possible to hide the *ACCSS*' list, which always displays the code: 'L, SE'.)

### Promoting a parameter

Scroll through the lists to the required parameter and choose the 'PrO' code. The parameter is then automatically added (promoted) into the Home display list. (The parameter will also be accessible, as normal, from the standard lists.) A maximum of twelve parameters can be promoted. Promoted parameters are automatically 'alterable'.

Please note, in the 'PrOG L, SE', the parameters from segment number (SEG.n) onwards *cannot* be promoted.

## Chapter 4 TUNING

Before tuning, please read Chapter 2, *Operation*, to learn how to select and change a parameter.

This chapter has five topics:

- WHAT IS TUNING?
- AUTOMATIC TUNING
- MANUAL TUNING
- COMMISSIONING OF MOTORISED VALVE CONTROLLERS
- GAIN SCHEDULING

### WHAT IS TUNING?

In tuning, you match the characteristics of the controller to those of the process being controlled in order to obtain good control. Good control means:

- Stable, 'straight-line' control of the temperature at setpoint without fluctuation
- No overshoot, or undershoot, of the temperature setpoint
- Quick response to deviations from the setpoint caused by external disturbances, thereby rapidly restoring the temperature to the setpoint value.

Tuning involves calculating and setting the value of the parameters listed in Table 4-1. These parameters appear in the '*P, d*' list.

Parameter	Code	Meaning or Function
Proportional band	$Pb$	The bandwidth, in display units, over which the output power is proportioned between minimum and maximum.
Integral time	$t_i$	Determines the time taken by the controller to remove steady-state error signals.
Derivative time	$t_d$	Determines how strongly the controller will react to the rate-of-change of the measured value.
High Cutback	$Hcb$	The number of display units, above setpoint, at which the controller will increase the output power, in order to prevent undershoot on cool down.
Low cutback	$Lcb$	The number of display units, below setpoint, at which the controller will cutback the output power, in order to prevent overshoot on heat up.
Relative cool gain	$rEL$	Only present if cooling has been configured and a module is fitted. Sets the cooling proportional band, which equals the $Pb$ value divided by the $rEL$ value.

Table 4-1 Tuning parameters

## AUTOMATIC TUNING

Two automatic tuning methods are provided in the 2408 and 2404:

- A **one-shot tuner**, which automatically sets up the initial values of the parameters listed in Table 4-1 on the previous page.
- **Adaptive tuning**, which continuously monitors the error from setpoint and modifies the PID values, if necessary.

### One-shot Tuning

The 'one-shot' tuner works by switching the output on and off to induce an oscillation in the measured value. From the amplitude and period of the oscillation, it calculates the tuning parameter values.

If the process cannot tolerate full heating or cooling being applied during tuning, then the level of heating or cooling can be restricted by setting the heating and cooling power limits in the '**OP**' list. However, the measured value *must* oscillate to some degree for the tuner to be able to calculate values.

A One-shot Tune can be performed at any time, but normally it is performed only once during the initial commissioning of the process. However, if the process under control subsequently becomes unstable (because its characteristics have changed), you can re-tune again for the new conditions.

It is best to start tuning with the process at ambient temperature. This allows the tuner to calculate more accurately the low cutback and high cutback values which restrict the amount of overshoot, or undershoot.

### How to tune

1. Set the setpoint to the value at which you will normally operate the process.
2. In the '**ALtun**' list, select '**tunE**' and set it to '**on**'.
3. Press the Page and Scroll buttons together to return to the Home display. The display will flash '**tunE**' to indicate that tuning is in progress.
4. The controller induces an oscillation in the temperature by first turning the heating on, and then off. The first cycle is not complete until the measured value has reached the required setpoint.
5. After two cycles of oscillation the tuning is completed and the tuner switches itself off.
6. The controller then calculates the tuning parameters listed in Table 4-1 and resumes normal control action.

If you want 'Proportional only', 'PD', or 'PI' control, you should set the '**t<sub>1</sub>**' or '**t<sub>d</sub>**' parameters to **OFF** before commencing the tuning cycle. The tuner will leave them off and will not calculate a value for them.

## Typical automatic tuning cycle

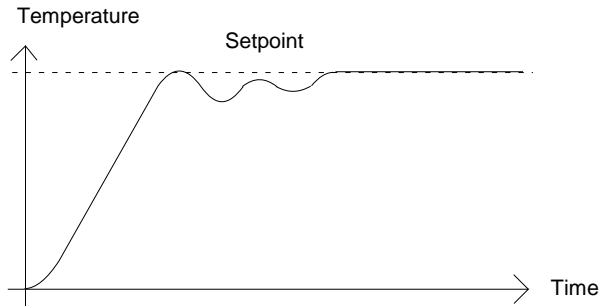

## Calculation of the cutback values

*Low cutback* and *High cutback* are values that restrict the amount of overshoot, or undershoot, that occurs during large step changes in temperature (for example, under start-up conditions).

If either low cutback, or high cutback, is set to 'Auto' the values are fixed at three times the proportional band, and are not changed during automatic tuning.

## Adaptive tune

Adaptive tuning is a background algorithm, which continuously monitors the error from setpoint and analyses the control response during process disturbances. If the algorithm recognises an oscillatory, or under-damped, response it recalculates the  $Pb$ ,  $t_i$  and  $t_d$  values.

Adaptive tune is triggered whenever the error from setpoint exceeds a trigger level. This trigger level is set in the parameter 'drift', which is found in the Autotune list. The value is in display units. It is automatically set by the controller, but can also be manually re-adjusted.

*Adaptive tune should be used with:*

1. Processes whose characteristics change as a result of changes in the load, or setpoint.
2. Processes that cannot tolerate the oscillation induced by a One-shot tune.

*Adaptive tune should not be used:*

1. Where the process is subjected to regular external disturbances that could mislead the adaptive tuner.
2. On highly interactive multiloop applications. However, moderately interactive loops, such as multi-zone extruders, should not give a problem.



## MANUAL TUNING

If for any reason automatic tuning gives unsatisfactory results, you can tune the controller manually. There are a number of standard methods for manual tuning. The one described here is the Ziegler-Nichols method.

With the process at its normal running temperature:

1. Set the Integral Time ' $t_i$ ' and the Derivative Time ' $t_d$ ' to *OFF*.
2. Set High Cutback and Low Cutback, ' $Hcb$ ' and ' $Lcb$ ', to '*Auto*'.
3. Ignore the fact that the temperature may not settle precisely at the setpoint.
4. If the temperature is stable, reduce the proportional band ' $Pb$ ' so that the temperature just starts to oscillate. If the temperature is already oscillating, increase the proportional band until it just stops oscillating. Allow enough time between each adjustment for the loop to stabilise. Make a note of the proportional band value ' $B$ ' and the period of oscillation ' $T$ '.
5. Set the  $Pb$ ,  $t_i$ ,  $t_d$  parameter values according to the calculations given in Table 4-2.

Type of control	Proportional band ' $Pb$ '	Integral time ' $t_i$ '	Derivative time ' $t_d$ '
Proportional only	$2xB$	OFF	OFF
P + I control	$2.2xB$	$0.8xT$	OFF
P + I + D control	$1.7xB$	$0.5xT$	$0.12xT$

Table 4-2 Tuning values

### Setting the cutback values

The above procedure sets up the parameters for optimum steady state control. If unacceptable levels of overshoot or undershoot occur during start-up, or for large step changes in temperature, then manually set the cutback parameters ' $L_{cb}$ ' and ' $H_{cb}$ '.

#### *Proceed as follows:*

1. Set the low and high cutback values to three proportional bandwidths (that is to say,  $L_{cb} = H_{cb} = 3 \times P_b$ ).
2. Note the level of overshoot, or undershoot, that occurs for large temperature changes (see the diagrams below).

In example (a) increase ' $L_{cb}$ ' by the overshoot value. In example (b) reduce ' $L_{cb}$ ' by the undershoot value.

#### **Example (a)**

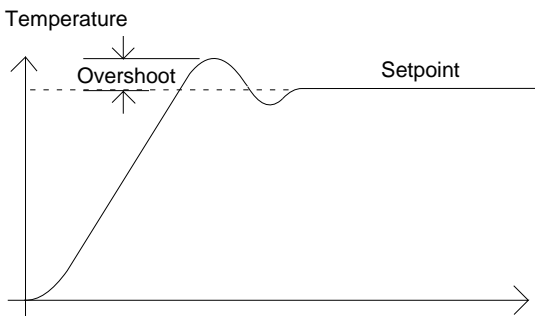

#### **Example (b)**

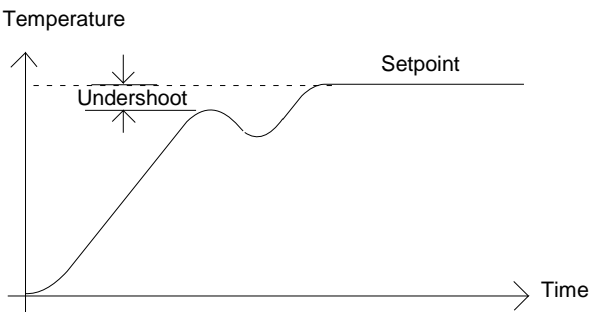

Where the temperature approaches setpoint from above, you can set ' $H_{cb}$ ' in a similar manner.

### Integral action and manual reset

In a full three-term controller (that is, a PID controller), the integral term 'ti' automatically removes steady state errors from the setpoint. If the controller is set up to work in two-term mode (that is, PD mode), the integral term will be set to 'OFF'. Under these conditions the measured value may not settle precisely at setpoint. When the integral term is set to 'OFF' the parameter *manual reset* (code 'rES') appears in the 'P, DL, SE' in 'FULL' level. This parameter represents the value of the power output that will be delivered when the error is zero. You must set this value manually in order to remove the steady state error.

### Automatic droop compensation (Adc)

The steady state error from the setpoint, which occurs when the integral term is set to 'OFF', is sometimes referred to as 'droop'. 'Adc' automatically calculates the manual reset value in order to remove this droop. To use this facility, you must first allow the temperature to stabilise. Then, in the autotune parameter list, you must set 'Adc' to 'CALC'. The controller will then calculate a new value for manual reset, and switch 'Adc' to 'MAN'.

'Adc' can be repeated as often as you require, but between each adjustment you must allow time for the temperature to stabilise.

### Tune Error

If any one stage of the automatic tuning process is not completed within two hours a diagnostic alarm will occur. The display shows **TUNE** - Tune Error.

This alarm could occur if:

1. The process to be tuned has a very slow response time
2. The sensor has failed or is incorrectly aligned
3. The loop is broken or not responding correctly

## MOTORISED VALVE CONTROL

The 2408 and 2404 can be configured for motorised valve control as an alternative to the standard PID control algorithm. This algorithm is designed specifically for positioning motorised valves.

These are ordered pre-configured as Model numbers:

- 2408/VC and 2404/VC motorised valve controllers
- 2408/VP and 2404/VP motorised valve controllers with a single setpoint programmer
- 2408/V4 and 2404/V4 motorised valve controllers storing four setpoint programs.
- 2408/VM and 2404/VM motorised valve controllers storing twenty setpoint programs.

Figure 1-11 in Chapter 1 shows how to connect a motorised valve controller. The control is performed by delivering open, or close, pulses in response to the control demand signal.

The motorised valve algorithm can operate in one of three ways:

1. The so-called *boundless* mode, which does not require a position feedback potentiometer for control purposes; although one can be connected and used purely to display the valve's position.
2. Bounded, (*or position*), control mode, which requires a feedback potentiometer. This is closed-loop control determined by the valve's position.

The desired control mode is selected in the 'rnsE' list in configuration level.

The following parameter list will appear in the navigation diagram shown in Chapter 2, if your controller is configured for motorised valve control.

Name	Description	Values		
<b>mEr</b>	<b>Motor list</b>	<b>Min</b>	<b>Max</b>	<b>Default</b>
t <sub>m</sub>	Valve travel time in seconds. This is the time taken for the valve to travel from its fully closed position to its fully open position.	0.1	240.0	30.0
l <sub>nt</sub>	Valve inertia time in seconds. This is the time taken for the valve to stop moving after the output pulse is switched off.	OFF	20.0	OFF
bRc <sub>t</sub>	Valve backlash time in seconds. This is the minimum on-time required to reverse the direction of the valve. i.e. the time to overcome the mechanical backlash.	OFF	20.0	OFF
mP <sub>t</sub>	Output pulse minimum on-time, in seconds.	Auto	100.0	Auto
Ubr	Valve sensor break strategy.	rEst, uP, dwn		rEst

Table 4-3 Motorised valve parameter list

## COMMISSIONING THE MOTORISED VALVE CONTROLLER

The commissioning procedure is the same for both bounded and boundless control modes, except in bounded mode you must first calibrate the position feedback potentiometer, as described in the section below.

Proceed as follows:

1. Measure the time taken for the valve to be raised from its fully closed to its fully open position and enter this as the value in seconds into the ' $t_m$ ' parameter.
2. Set all the other parameters to the default values shown in Table 4-3.

The controller can then be tuned using any of the automatic, or manual, tuning procedures described earlier in this chapter. As before, the tuning process, either automatic or manual, involves setting the values of the parameters in Table 4-1. The only difference with boundless control is that the derivative term ' $t_d$ ', although present, will have no effect.

### Adjusting the minimum on-time ' $mP_t$ '

The default value of 0.2 seconds is satisfactory for most processes. If, however, after tuning the process, the valve activity is excessively high, with constant oscillation between raise and lower pulses, the minimum on-time can be increased.

The minimum on-time determines how accurately the valve can be positioned and therefore the control accuracy. The shorter the time, the more precise the control. However, if the time is set too short, process noise will cause an excessively busy valve.

### Inertia and backlash settings

The default values are satisfactory for most processes, i.e. ' $OFF$ '.

**Inertia** is the time taken for the valve to stop after the output pulse is turned off. If this causes a control problem, the inertia time needs to be determined and then entered into the parameter, ' $I_{nt}$ '. The inertia time is subtracted from the raise and lower output pulse times, so that the valve moves the correct distance for each pulse.

**Backlash** is the output pulse time required to reverse the direction of the valve, i.e. the time taken to overcome the mechanical backlash of the linkages. If the backlash is sufficient to cause a control problem, then the backlash time needs to be determined and then entered into the parameter, ' $BACK_t$ '.



The above two values are not part of the automatic tuning procedure and must be entered manually.























## CALIBRATING THE POSITION FEEDBACK POTENTIOMETER

Before proceeding with the feedback potentiometer calibration, you should ensure, in configuration level, that module position 2 ( $2A$ ), or 3 ( $3A$ ), has its ' $d$ ' indicating ' $Pot_t$ ', (meaning *Potentiometer Input*). Continue to scroll down the module configuration list.

' $Func$ ' should be set to ' $UPoS$ ', ' $VAL_L$ ' must be set to ' $0$ ' and ' $VAL_H$ ' to ' $100$ '.

Exit from configuration and you are now ready to calibrate the position feedback potentiometer. Proceed as follows.

1. In Operator level, press the AUTO/MAN button to put the controller in Manual mode.
2. Drive the valve to its fully open position using .
3. Press  until you get to ' $P-L, St$ '.
4. Press  to get to ' $PCAL-OFF$ '.

5. Press  or  to turn 'PCAL' to 'on'.
6. Press  and the upper readout indicates 'Pot'.
7. Press  or  to get to 'Pot-3AHi'. (Assuming that the Potentiometer Input Module is in module position 3.)
8. Press  to go to 'GO-no'.
9. Press  or  to see 'GO-YES', which starts the calibration procedure.
10. Calibration is complete when the display returns to 'GO-no'.
11. Press  and  together to return directly to the Operator level.
12. The controller should still be in Manual mode.
13. Drive the valve to its fully closed position using .
14. Press  until you get to 'P-L, St'.
15. Press  to get to 'PCAL-OFF'.
16. Press  or  to turn 'PCAL' to 'on'.
17. Press  and the upper readout indicates 'Pot'.
18. Press  or  to get to 'Pot-3ALo'.
19. Press  to go to 'GO-no'.
20. Press  or  to see 'GO-YES', which starts the calibration procedure.
21. Calibration is complete when the display returns to 'GO-no'.
22. Press  and  together to return directly to the Operator level.
23. Press the AUTO/MAN button to place the controller in AUTO and the calibration of the position feedback potentiometer is now complete.

## GAIN SCHEDULING

Gain scheduling is the automatic transfer of control between one set of PID values and another. In the case of the 2408 and 2404 controllers, this is done at a presettable process value. It is used for the more difficult to control processes which exhibit large changes in their response time or sensitivity at, for example, high and low temperatures, or when heating or cooling.

The 2408 and 2404 has two sets of PID values. You can select the active set from either a digital input, or from a parameter in the PID list, or you can transfer automatically in gain scheduling mode. The transfer is bumpless and will not disturb the process being controlled.

To use gain scheduling, follow the steps below:

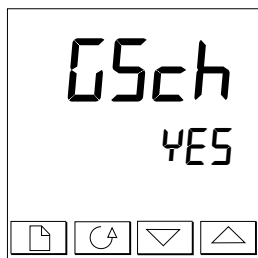

### Step 1: Enable in configuration level

Gain scheduling must first be enabled in Configuration level. Goto the *Inst Conf* list, select the parameter *GSch*, and set it to *YES*.

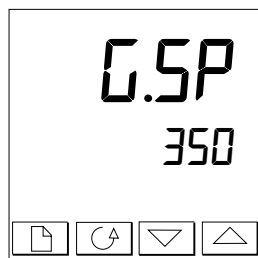

### Step 2: Set the transfer point

Once gain scheduling has been enabled, the parameter *G.SP* will appear at the top of the *PID* list in *FULL* access level. This sets the value at which transfer occurs. PID1 will be active when the process value is below this setting and PID2 when the process value is above it. The best point of transfer depends on the characteristics of the process. Set a value between the control regions that exhibit the greatest change.

### Step 3: Tuning

You must now set up the two sets of PID values. The values can be manually set, or automatically tuned as described earlier in this chapter. When tuning automatically you must tune twice, once above the switching point *G.SP* and again below the switching point. When tuning, if the process value is below the transfer point *G.SP* the calculated values will automatically be inserted into PID1 set and if the process value is above *G.SP*, the calculated values will automatically be inserted into PID2 set.

## Chapter 5 PROGRAMMER OPERATION

This chapter deals with the setpoint programming option. All 2408 / 2404 instruments have a basic 8-segment programmer built-in as standard. This facility must be enabled by the user, as explained in the section, *Configuring the Programmer*.

Other programmer versions are listed below, and have 16-segments in each program.

16-segment programmer with:

a single program:	Models 2408/CP and 2404/CP.
four stored programs:	Models 2408/P4 and 2404/P4.
twenty stored programs:	Models 2408/CM and 2404/CM.

16-segment Motorised Valve programmer with:

a single program:	Models 2408/VP and 2404/VP.
four stored programs:	Models 2408/V4 and 2404/V4.
twenty stored programs:	Models 2408/VM and 2404/VM.

The 8-segment programmer differs from the other programmers in that it will not provide event outputs and program synchronisation. Otherwise they all operate in the same way.

There are eight topics:

- WHAT IS SETPOINT PROGRAMMING?
- PROGRAMMER STATES
- RUNNING A PROGRAM FROM THE RUN LIST
- RUNNING A PROGRAM USING THE RUN/HOLD BUTTON
- AUTOMATIC BEHAVIOUR
- CONFIGURING THE PROGRAMMER
- CONFIGURING DIGITAL INPUTS TO SELECT PROGRAM NUMBER
- CREATING A NEW PROGRAM, OR MODIFYING AN EXISTING PROGRAM.

To understand how to select and change parameters in this chapter you need to have read Chapter 2, *Operation* and Chapter 3, *Access Levels*.



## WHAT IS SETPOINT PROGRAMMING?

Many applications need to vary temperature, or process value, with time. Such applications need a controller which varies a setpoint as a function of time; all 2408 and 2404 models can do this.

The setpoint is varied by using a *setpoint program*. Within each 2408 and 2404 controller, there is a software module called *the programmer*, which stores one, or more, such programs and drives the setpoint according to the selected program. The program is stored as a series of 'ramp' and 'dwell' segments, as shown below.

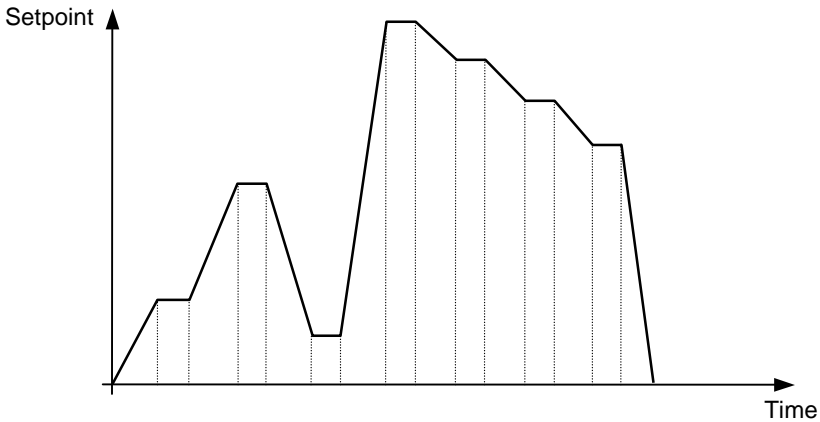

Fig 5-1 Setpoint profile

(If the 8-segment programmer is being used, then the information in the next paragraph does **not** apply.) In each segment you can define the state of up to eight (8) digital outputs, each of which can be used to trigger external events. These are called *event outputs* and can drive either relay, logic, or triac outputs, depending on the modules installed.

A program is executed either, once, repeated a set number of times, or repeated continuously. If repeated a set number of times, then the number of cycles must be specified as part of the program.

There are five different types of segment:



<b>Ramp</b>		<b>The setpoint ramps linearly</b> , from its current value to a new value, either at a set rate (called <i>ramp-rate programming</i> ), or in a set time (called <i>time-to-target programming</i> ). You must specify the ramp rate or the ramp time, and the target setpoint, when creating or modifying a program.
<b>Dwell</b>		<b>The setpoint remains constant</b> for a specified period.
<b>Step</b>		<b>The setpoint steps instantaneously</b> from its current value to a new value.
<b>Call</b>		<b>The main program calls another program as a subroutine.</b> The called program then drives the setpoint until it returns control to the main program. This facility is available on those controllers with 4, or 20, stored programs.
<b>End</b>		<b>The program either ends in this segment, or repeats.</b> You specify which is the case when you create, or modify, the program (see the final topic in this chapter). When the program ends, the programmer is put into either, a continuous Dwell state with all outputs staying unchanged, or the Reset state, or to a settable power level.

Table 5-1 Segment Types

## PROGRAMMER STATES

The programs have five states: *Reset*, *Run*, *Hold*, *Holdback* and *End*.

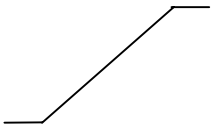
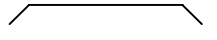
State	Description	Indication
<b>Reset</b>	In Reset, the programmer is inactive and the controller behaves as a standard controller, with the setpoint determined by the value set in the lower readout.	<b>Both the RUN and HOLD lights are OFF</b>
<b>Run</b>	In Run, the programmer varies the setpoint according to the active program.	<b>RUN light on</b>
<b>Hold</b>	In Hold, the program is frozen at its current point. In this state you can make temporary changes to any program parameter (for example, a target setpoint, a dwell time, or the time remaining in the current segment). <b>Such changes will only remain effective until the program is reset and run again, when they will be overwritten by the stored program values.</b>  <b>Note:</b> When a program is running, you <u>cannot</u> alter a <b>CALL</b> ed program until it becomes active within that program.	<b>HOLD light on</b>
<b>Holdback</b>	Holdback indicates that the measured value is lagging the setpoint by more than a preset amount and that the program is in Hold, waiting for the process to catch up. See <i>Holdback</i> in the section on Automatic behaviour later this chapter.	<b>HOLD light flashes</b>
	A master controller can re-transmit a setpoint value to a number of slave units using PDSIO setpoint retransmission. Any of the slave units can generate a holdback signal which will also flash the <b>HOLD</b> light. Holdback will also occur if the PDSIO output is open circuit. This can be disabled in configuration by selecting the <b>PDS</b> output as <b>SP.nH</b> - 'setpoint retransmission without holdback'	<b>HOLD light flashes</b>
<b>End</b>	The program is complete.	<b>RUN light flashes</b>

Table 5-2 Program States

## RUNNING A PROGRAM FROM THE RUN LIST

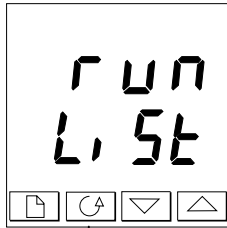

### The Run List

From the Home display, press until you reach the 'run' list header.



Press .

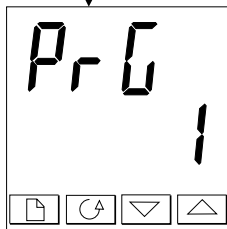

### Program number

This display only appears on programmers that can store more than one program. Use or to select the required program number, from 1 to 4, or 1 to 20, depending on the particular controller.

Alternatively, the program number can be selected remotely, using digital inputs on the rear terminals. See the section on *Configuring Digital Inputs to Select a Program Number* for information on how this is done.



Press .

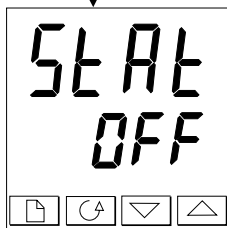

### Status selection

Use or to select:

- **run:** Run program.
- **hold:** Hold program.
- **OFF:** Program reset.

After two seconds, the lower readout blinks and the chosen state is now active.

To return to the Home display press and together.

### Other parameters

To access the other parameters in the 'run' list, continue to press . These parameters are shown in the 'Program run list' in Chapter 2, Parameter Tables. They show the current status of the active program.

### Temporary changes

Temporary changes can be made to the parameters in this 'run' list, (for example a setpoint, ramp rate, or an unelapsed time), by first placing the programmer into 'hold'. Such changes remain active only for the duration of the segment; the segment parameters will revert to their original (stored) values whenever the segment is re-executed.

## RUNNING A PROGRAM USING THE RUN/HOLD BUTTON

If you are using a 4, or 20, program version of the controller, you must first select the number of the program that you want to run. Do this in the 'RUN' list – see the previous topic, *Running a program from the Run list*.

Then:

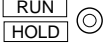
	<p>RUN / HOLD button</p>	<p>Press once to run a program (RUN light on) Press again to hold a program (HOLD light on) Press again to cancel hold and continue running (HOLD light off, RUN light on) Press and hold in for two seconds to reset a program (RUN and HOLD lights off).</p>
---	------------------------------	--

**Note:** The RUN/HOLD button can be disabled, either when ordering the controller, or subsequently in configuration. This will force you to operate the programmer from the 'RUN' list all the time. The main advantage of this method is that it will reduce the chance of accidentally changing the state of a program.

## AUTOMATIC BEHAVIOUR

The preceding topics explain how to operate the programmer manually.

The following topics cover aspects of its automatic behaviour: *Servo*, *Holdback* and *Power Failure*.

### Servo

When a program is RUN, the setpoint can start either from the initial controller setpoint, or from the process value. Whichever it is, the starting point is called the 'servo' point and you set it up in configuration. When the program starts, the transition of the setpoint to its starting point is called 'servoing'.

The normal method is to servo to the process value, because this will produce a smooth and bumpless start to the process. However, if you want to guarantee the time period of the first segment, you should set the controller to servo to its setpoint.

### Holdback

As the setpoint ramps up, or down (or dwells), the measured value may lag behind, or deviate from, the setpoint by an undesirable amount. 'Holdback' is available to freeze the program at its current state, should this occur. The action of Holdback is the same as a deviation alarm. It can be enabled, or disabled. Holdback has **two** parameters - a *value* and a *type*.

If the error from the setpoint exceeds the set 'holdback' value, then the Holdback feature, if enabled, will automatically freeze the program at its current point and flash the HOLD light. When the error comes within the holdback value, the program will resume normal running.

There are *four* different Holdback types. The choice of type is made by setting a parameter when creating a program, and may be one of the following:–

'**0FF**' – **Disables Holdback** – therefore no action is taken.

- 'Lo' – **Deviation Low Holdback** holds the program back when the process variable deviates *below* the setpoint by more than the holdback value.
- 'Hi' – **Deviation High Holdback** holds the program back when the process variable deviates *above* the setpoint by more than the holdback value.
- 'band' – **Deviation Band Holdback** is a combination of the two. It holds the program back when the process variable deviates *either above, or below*, the setpoint by more than the holdback value.

There is a single Holdback Value which applies to the whole program. However, the Holdback type and whether or not it is enabled, can be applied to the program as a whole, or individually in each segment.

**Power failure**

If power is lost and then restored, while a program is running, the behaviour of the programmer is determined by the setting of the parameter '*PwrF*' *Power fail strategy* in Programmer configuration. This can have one of three settings:- *cont* (Continue), *rmpb* (Ramp from PV), or *rset* (Reset).

*If 'cont' is selected*, then when power is restored the program continues from where it was interrupted when power was lost. All parameters, such as the setpoint and time remaining in the active segment, will be restored to their power-down values. For applications that need to bring the measured process value to the setpoint as soon as possible, this is the best strategy.

*If 'rmpb' is selected*, then when power is restored the setpoint starts at ('servos to') the current measured value, and then ramps to the target setpoint of the active segment at the last ramp rate used by the program. This strategy provides a smoother recovery. The two diagrams below illustrate the respective responses, Fig 5-2 if power fails during a dwell segment and Fig 5-3 if it fails during a ramp segment.

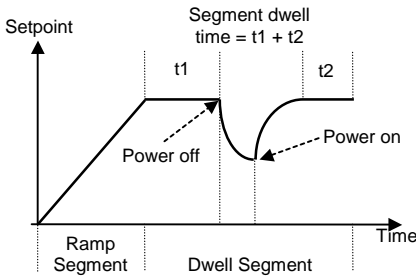

Figure 5-2 Continue after a power fail

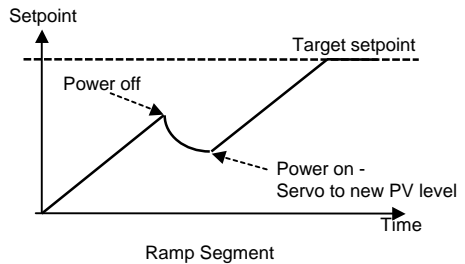

Figure 5-3 Ramp back after a power fail

*If 'rset' is selected*, then when power is restored the program terminates.

## CONFIGURING THE PROGRAMMER

When first installing a programmer you should check that the configuration conforms to your requirement.

Configuration defines:

- the number of stored programs *(multi-programmer only)*
- the holdback strategy
- the power fail strategy
- the servo type
- if event outputs are available *(not 8-segment programmer)*
- if program synchronisation is available. *(not 8-segment programmer)*
- selection of program number using digital inputs *(multi-programmer only)*

**To check, or change,** the configuration, select Configuration level. See Chapter 6.

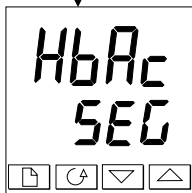
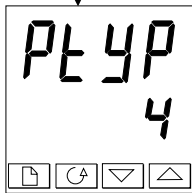
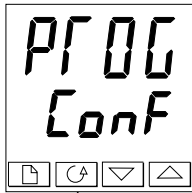

### Programmer list header

After selecting Configuration mode, press  until the **PROG Conf** header is displayed.

Press 

### Number of programs

Use  or  to select:

- **nonE**: Disable built-in 8-segment programmer
- **!**: Enable built-in 8-segment programmer

For 16-segment programmers:

- **nonE**: no programs
- **!**: One stored program
- **4**: Four stored programs
- **20**: Twenty stored programs

Press 

### Holdback Strategy

Use  or  to select:

- **SEG**: Holdback type to be set in each segment
- **PROG**: Holdback type to be set for the whole program

Press 

*Continued on the next page.*

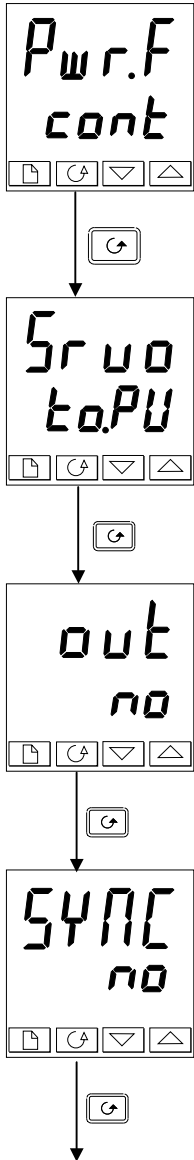

**Power fail strategy**

Use or to select

- **cont:** Continue from last setpoint
- **rmPb:** Ramp from PV to setpoint at last ramp rate
- **rSEt:** Reset the program.

Press

**Servo type**

Use or to select:

- **to.PV:** Servo to PV
- **to.SP:** Servo to SP

Press

**Event Outputs (not in 8-segment programmer)**

Use or to select:

- **no:** Event outputs disabled
- **YES:** Event outputs enabled

Press

**Synchronisation (not in 8-segment programmer)**

Use or to select:

- **no:** Synchronisation disabled
- **YES:** Synchronisation enabled

Press to return the list header.



## CONFIGURING DIGITAL INPUTS TO SELECT PROGRAM NUMBER

The program number can be selected by external BCD inputs from, for example, a thumbwheel switch.



The appropriate number of digital inputs must be installed in the controller and be configured for this function - see Chapter 6, *Configuration*.

To invoke this mode of operation, the parameter 'bcd' in 'i nSt-CONF' must be set to 'PrOG'.

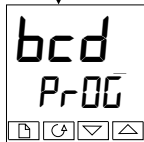

Press  until you reach 'bcd'.



Use the  or  buttons, to select 'PrOG'.

## CREATING A NEW PROGRAM, OR MODIFYING AN EXISTING ONE

The only difference between creating a new program, and modifying an existing one, is that a new program starts with all its segments set to *End* in the *TYPE* parameter. The procedure for both consists of setting up the parameters in the *PROG* list of the Operator Navigation Diagram shown in Chapter 2. As explained earlier under 'Programmer states', temporary changes can be made to these parameters while in the *HOLD* state but permanent changes (to the stored values) can only be made when the programmer is in the *Reset* state. So, before modifying a stored program first make sure that it is in *Reset* and then follow the procedure below.

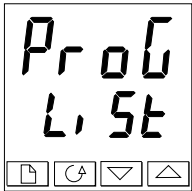

### Program edit list

From the Home display press until you reach the *Pr oG* *L, St* header.

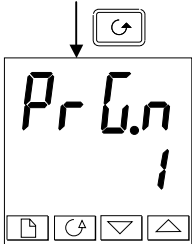

Press

### Program number

This display appears only on the multi-program controllers. Use or to select the number of the program which you wish to modify (from 1 to 4, or 1 to 20).

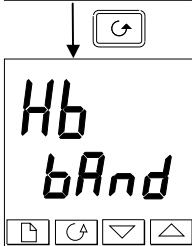

Press

### Holdback type

[Only appears when Holdback has been selected for the whole program.]

Use or to select:

- *OFF*: Holdback disabled
- *L o*: Deviation Low Holdback
- *H i*: Deviation High Holdback
- *bAnd*: Deviation Band Holdback

Press

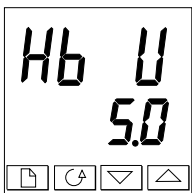

### Holdback value

**Note!** The value set in this parameter is always for the whole program.

Use or to set the value.

Press

*Continued on the next page.*

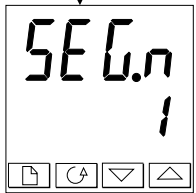
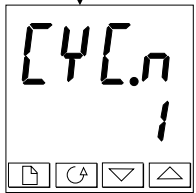
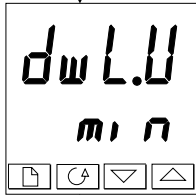
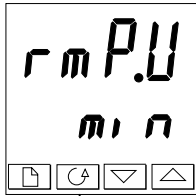

**Ramp units**

Use  or  to select:

- SEc
- m i n
- Hour

Press 



**Dwell units**

Use  or  to select:

- SEc
- m i n
- Hour



Press 

**Number of program cycles**

Use  or  to set the number of program cycles required from 1 to 999, or 'cont' for continuous cycling.

Press 

**Segment number**

Use  or  to select the number, from 1 to 16. (1 to 8 in 8-segment programmers)

The parameters that follow 'SEG.n' set up the characteristics of the individually-selected segment number. By defining the characteristics of each segment of the program, you define the whole program.

Press 

*Continued on the next page.*

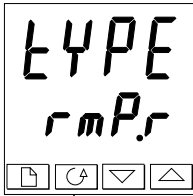

**Segment type**

Select the segment type using or .

- *rmPr*: Ramp to a new setpoint at a set rate
- *rmPt*: Ramp to a new setpoint in a set time
- *dwEll*: Dwell for a set time
- *StEP*: Step to a new setpoint
- *cALL*: Call another program as a subroutine  
*(only available in multi-program controllers)*
- *End*: Make this segment the end of the program.

Press

The parameters that follow 'TYPE' depend on the type of segment selected as shown in the table below. The function of each parameters follows the table.

Parameter	Segment type selected					
	<i>rmPr</i>	<i>rmPt</i>	<i>dwEll</i>	<i>StEP</i>	<i>cALL</i>	<i>End</i>
Hb	✓	✓	✓	✓		
tGt	✓	✓		✓		
rALlE	✓					
dur		✓	✓			
PrGn					✓	
cYcn					✓	
outn	✓	✓	✓	✓		✓
Sync	✓	✓	✓	✓		
Endt						✓
Pwr						✓

Table 5-3 Parameters that follow segment type

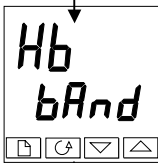

**Holdback type**

Only appears when Holdback per segment has been selected.

Use or to select:

- *OFF*: Holdback disabled
- *Lo*: Deviation Low Holdback
- *Hi*: Deviation High Holdback
- *bAnd*: Deviation Band Holdback

Press

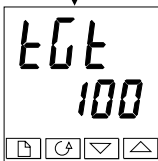

**Target setpoint**

Target setpoint for '*rmPr*', '*rmPt*' or '*StEP*' segments.

Set the target setpoint using or .

Press

*Continued on the next page.*

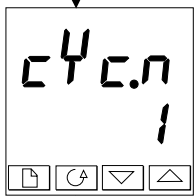
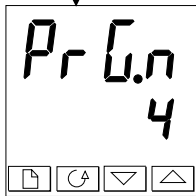
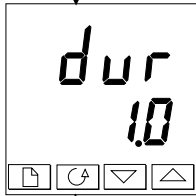
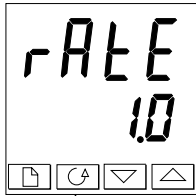

**Ramp rate**

Ramp rate for 'rP.L' segments

Using or , set a value for the ramp rate, ranging from 0.0 to 999.9. The units are the ramp units (rP.U) set earlier in this sequence.

Press

**Duration time**

Time for a 'dwE.L' segment, or time to target for a 'rP.L' segment.

Set the time using or . You have set the units earlier in this sequence. ['dwL.U' defines the units for 'dwE.L' segments; 'rP.U' defines the units for 'rP.L' segments.]

Press

**Called program number**

Only appears for 'cALL' segments. *(multi-program controllers only)*

Set a called program number from 1 to 4, or from 1 to 20, using or .

Press

**Number of cycles of the cALLED program**

Only appears for 'cALL' segments. *(multi-program controllers only)*

Sets the number of cycles of the cALLED program from 1 to 999, using or .

Press

*Continued on the next page.*

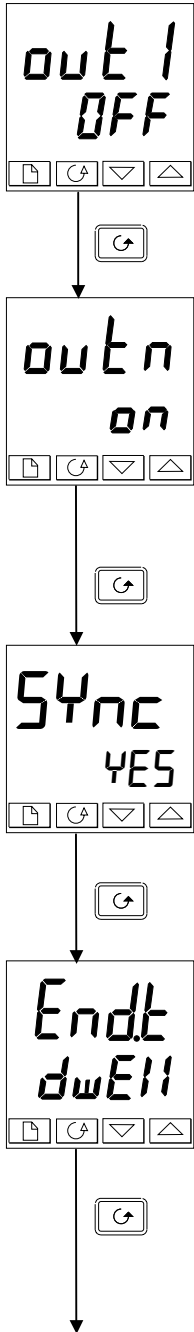

**Event output 1**

(16-segment programmers only)

Appears in all segments, except 'CALL' segments.

Use or to set output 1:

- OFF: Off in the current segment
- on: On the current segment.

Press

**Further event outputs**

(16-segment programmers only)

Up to eight (8) event outputs may appear in this list where 'n' = event number.

Pressing will step through all the remaining event outputs.

**Note:** If you are not using all of the event outputs, you can step immediately to the next segment number by pressing .

Press

**Synchronisation event output** (only appears if configured)

Use or to select:

- YES: Synchronisation Enabled
- no: Synchronisation Disabled

**Note:** This event output, if used, occupies the position of 'outB'.

Press

**End segment**

Use or to select:

- dwEll: An indefinite dwell
- rSEt: Reset.
- S OP: End Segment Output Power Level

Press

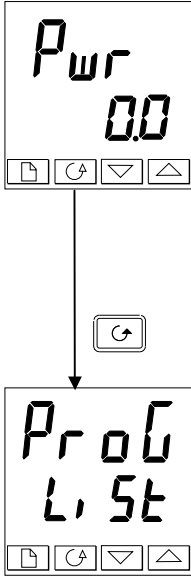

**Power Value [End Segment]**

Use or to set the power value in the range  $\pm 100.0\%$ . This power level is clipped by the parameters 'OPH' and 'OPL' before being applied to the process.

**Note:** In programmer/controller software versions 3.56 onwards this parameter has been replaced by a parameter **EndP** which appears at the end of the Output List, see Chapter 2

Press to return to the Prog-L, St header.

## Chapter 6 CONFIGURATION

This chapter consists of six topics:

- SELECTING CONFIGURATION LEVEL
- LEAVING CONFIGURATION LEVEL
- SELECTING A CONFIGURATION PARAMETER
- CHANGING THE PASSWORDS
- NAVIGATION DIAGRAM
- CONFIGURATION PARAMETER TABLES.

In configuration level you set up the fundamental characteristics of the controller. These are:

- The type of control (e.g. reverse or direct acting)
- The Input type and range
- The Setpoint configuration
- The Alarms configuration
- The Programmer configuration
- The Digital input configuration
- The Alarm Relay configuration
- The Communications configuration
- The Modules 1, 2 & 3 configuration
- Calibration
- The Passwords.

---

### WARNING



**Configuration is protected by a password and should only be carried out by a qualified person, authorised to do so. Incorrect configuration could result in damage to the process being controlled and/or personal injury. It is the responsibility of the person commissioning the process to ensure that the configuration is correct.**

---



## SELECTING CONFIGURATION LEVEL

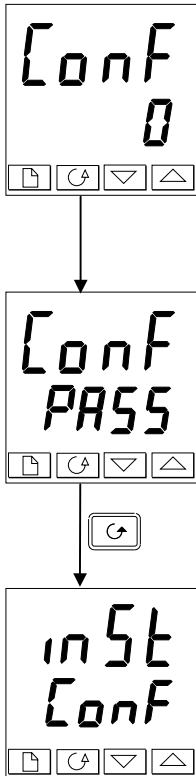

There are two alternative methods of selecting Configuration level:

- If you have already powered up, then follow the access instructions given in Chapter 3, *Access levels*.
- Alternatively, press  and  together when powering up the controller. This will take you directly to the 'CONF' password display.



### Password entry



When the 'CONF' display appears, you must enter the Configuration password (which is a number) in order to gain access to Configuration level.

Enter the password using the  or  buttons. The configuration password is set to '2' when the controller is shipped from the factory.

Once the correct password has been entered, there is a two second delay, after which the lower readout will change to 'PASS' indicating that access is now unlocked.

*Note:* A special case exists if the password has been set to '0'. In this situation, access is permanently unlocked and the lower readout will always show 'PASS'.



Press  to enter configuration.

(If an incorrect password has been entered and the controller is still 'locked' then pressing  at this point will take you to the 'Err' display with 'no' in the lower readout. Simply press  to return to the 'CONF' display.)



You will obtain the first display of configuration.

## LEAVING CONFIGURATION LEVEL

To leave the Configuration level and return to Operator level Press  until the 'E I t' display appears.

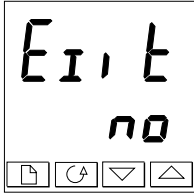
Alternatively, pressing  and  together will take you directly to the 'E I t' display.





Use  or  to select 'YES'. After a two-second delay, the display will blank and revert to the Home display in Operator level.

## SELECTING A CONFIGURATION PARAMETER



The configuration parameters are arranged in lists as shown in the navigation diagram in Figure 6.1.

**To step through the list headers**, press the Page  button.

**To step through the parameters** within a particular list press the Scroll  button. When you reach the end of the list you will return to the list header.

You can return directly to the list header at any time by pressing the Page  button.

### Parameter names

Each box in the navigation diagram shows the display for a particular parameter. The upper readout shows the name of the parameter and the lower readout its value. For a definition of each parameter, see the Configuration Parameter Tables at the end of this chapter. To change the value of a selected parameter, use the  and  buttons.

The navigation diagram shows all the lists headers and parameters that can, potentially, be present in the controller. In practice, those actually present will vary according to the particular configuration choices you make.

## CHANGING THE PASSWORDS

There are TWO passwords. These are stored in the Password configuration list and can be selected and changed in the same manner as any other configuration parameter.

The password names are:

'ACC.P'	which protects access to Full level and Edit level
'CNF.P'	which protects access to Configuration level.

**NAVIGATION DIAGRAM (PART A)**

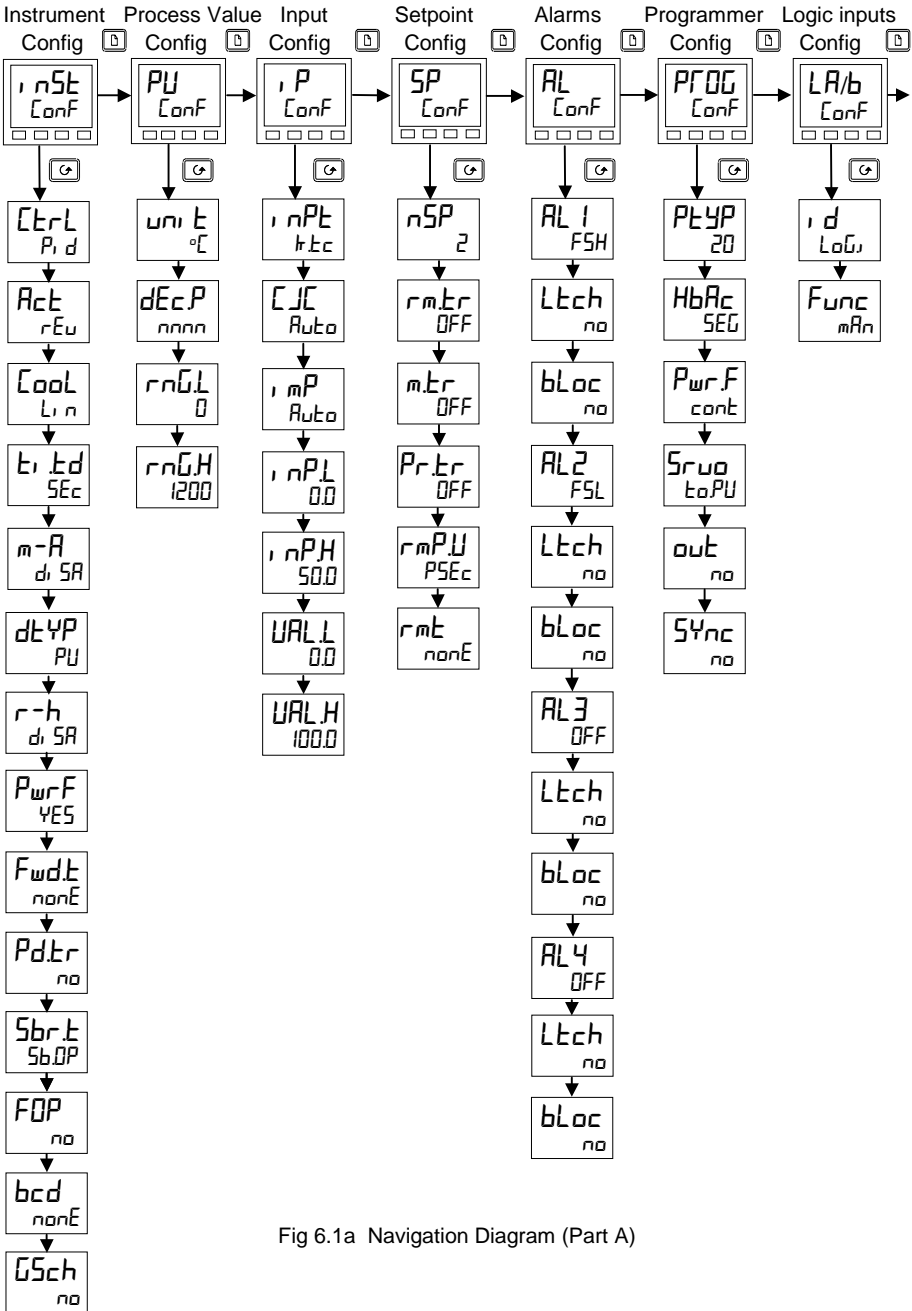
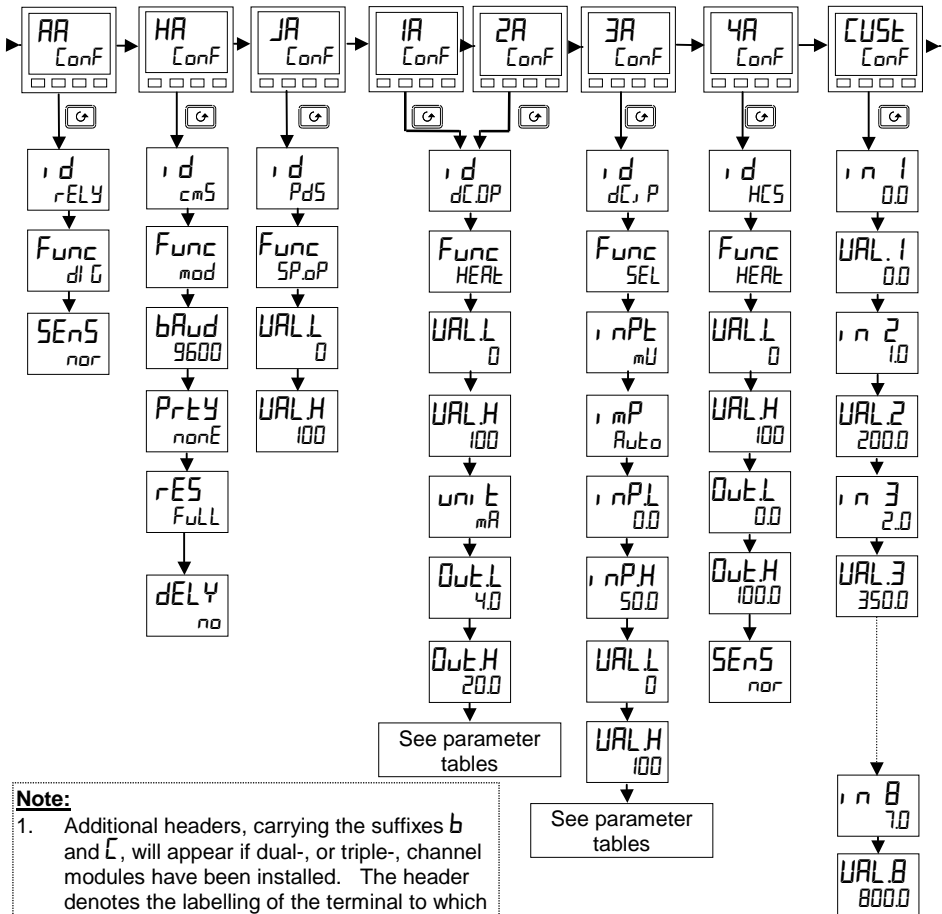

Fig 6.1a Navigation Diagram (Part A)

**NAVIGATION DIAGRAM (PART B)**

Alarm relay Config **B** Comms 1 Config **B** Comms 2 Config **B** Module 1 Config<sup>(1)</sup> **B** Module 2 Config<sup>(1)</sup> **B** Module 3 Config<sup>(1)</sup> **B** Module 4<sup>(2)</sup> Config **B** Custom<sup>(3)</sup> Config **B**



- Note:**
1. Additional headers, carrying the suffixes **b** and **L**, will appear if dual-, or triple-, channel modules have been installed. The header denotes the labelling of the terminal to which the output function is connected.
  2. Module 4 is the High Current Switch Module. This is only available in the Model 2404 controller on controllers manufactured before Jan-04.
  3. 8-point custom linearisation. Only appears when either **3A** or **IP-Conf** has 'nPt' = 'mUL', or 'mAL', or 'UL'.
  4. The navigation diagram shows typical parameters, but is dependant upon the exact configuration of the instrument. The following sheets show the full list of parameters.

Fig 6.1b Navigation Diagram (Part B)

**NAVIGATION DIAGRAM (PART C)**

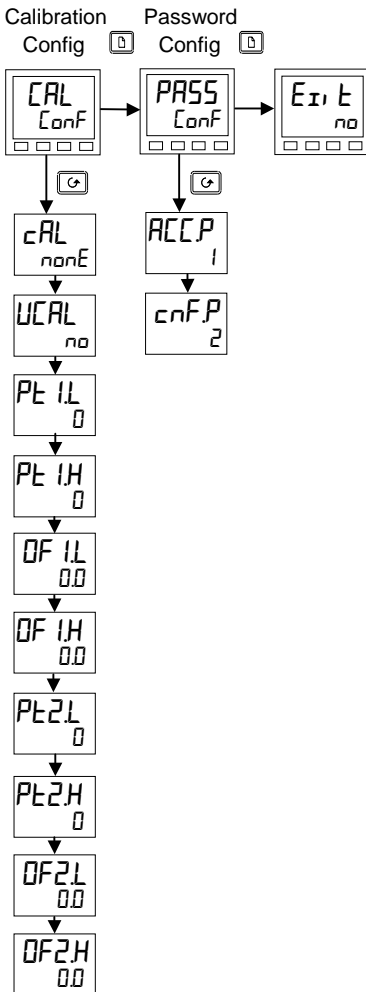

Fig 6.1c Navigation Diagram (Part C)

## CONFIGURATION PARAMETER TABLES

Name	Description	Values	Meaning
<b>Inst</b>	<b>Instrument configuration</b>		
<b>Ctrl</b>	Control type	PID On/Off UP  UP b	PID control On/off control Boundless motorised valve control - <i>no feedback required</i> Bounded motorised valve control - <i>feedback required</i>
<b>Act</b>	Control action	rEv dir	Reverse acting Direct acting
<b>Cool</b>	Type of cooling	Lin oil H2O Fan on/Off	Linear Oil (50mS minimum on-time) Water (non-linear) Fan (0.5S minimum on-time) On/off cooling
<b>Intd</b>	Integral & derivative time units	Sec min	Seconds, OFF to 9999 Minutes, OFF to 999.9
<b>dtYP</b>	Derivative type	PV Err	Operates on rate of change of PV Operates on rate of change of error
<b>m-A</b>	Front panel Auto/Man button	EnAb di SA	Enabled Disabled
<b>r-h</b>	Front panel Run/Hold button	EnAb di SA	Enabled Disabled
<b>PwrF</b>	Power feedback	on OFF	On Off
<b>Fwdt</b>	Feed forward type	nonE FEED SPFF PUFF	None Normal feed forward Setpoint feed forward PV feed forward
<b>Pdtr</b>	Manual/Auto transfer when using PD control	no YES	Non-bumpless transfer Bumpless transfer - ( <i>Pre-loads Manual Reset value</i> )
<b>Sbrt</b>	Sensor break output	SbOP Hold	Go to pre-set value Freeze output
<b>FOP</b>	Forced manual output	no trAc  StEP	Bumpless Auto/Manual transfer Returns to the Manual value that was set when last in Manual mode Steps to forced output level. Value set in 'FOP' of 'oP-L, St' in Operator Level
<b>bcd</b>	BCD input function	nonE ProG SP	Not used Select program number Select setpoint number
<b>Gsch</b>	Gain schedule enable	no YES	Disabled Enabled

Name	Description	Values	Meaning
<b>PU</b>	<b>Process value config</b>		
unit	Instrument units	C F K none	Celsius Fahrenheit Kelvin Display units blanked
decP	Decimal places in the displayed value	0 1 2	None One Two
rngL	Range low		Low range limit. Also setpoint limit for alarms and programmers
rngH	Range high		High range limit. Also setpoint limit for alarms and programmers

**Notes:****1. Pyrometer Emmissivity**

Controllers which are specifically supplied for pyrometer inputs (not Exergen K80), have the curve downloaded in the Custom Input. The parameter, **Emi 5**, Pyrometer Emmissivity, appears in the Input List on page 2-15. This parameter is also now correctly adjusted.

**2. Range**

If a decimal point was configured, negative display and setpoint ranges were limited to -99.9 in previous software versions. The range has been increased to -199.9 by combining the negative sign with the figure one. This allows Setpoints, Process Variables, Alarm Setpoints and Programmers to be set to -199.9.

Name	Description	Values	Meaning
------	-------------	--------	---------

$i, P$	Input configuration  * see 'CUSE' List.	Jtc Ktc Ltc Rtc Btc Ntc Ttc Stc PL 2 Ctc rtd mV VOLT mA Sr V Sr A mVc Vc mAc	J thermocouple K thermocouple L thermocouple R thermocouple (Pt/Pt13%Rh) B thermocouple (Pt30%Rh/Pt6%Rh) N thermocouple T thermocouple S thermocouple (Pt/Pt10%Rh) PL 2 thermocouple Custom downloaded t/c (default = type C) 100Ω platinum resistance thermometer Linear millivolt Linear voltage Linear milliamps Square root volts Square root milliamps 8-point millivolt custom linearisation* 8-point Voltage custom linearisation* 8-point milliamp custom linearisation*
CJC	Cold Junction Compensation	Auto 0°C 45°C 50°C OFF	Automatic internal compensation 0°C external reference 45°C external reference 50°C external reference No cold junction compensation
$i, mP$	Sensor Break Impedance	OFF  Auto Hi Hi Hi	Disabled (applies to any input) <b>Caution:</b> <b>If sensor break is disabled the controller will not detect open circuit faults</b> Factory set (Default i.e. enabled) Impedance of input > 5KΩ Impedance of input > 15KΩ

**Linear Input Scaling** – The next 4 parameters only appear if a linear or sq rt input is chosen.

$i, nPL$		Input value low
$i, nPH$		Input value high
UAL L		Displayed reading low
UAL H		Displayed reading high



Name	Description	Values	Meaning
<b>SP</b>	<b>Setpoint configuration</b>		
<i>nSP</i>	Number of setpoints	2, 4, 16	Select number of setpoints available
<i>rmTr</i>	Remote Tracking	OFF TrAc	Disable Local setpoint tracks remote setpoint
<i>mTr</i>	Manual Track	OFF TrAc	Disable Local setpoint tracks PV when in manual
<i>PrTr</i>	Programmer Track	OFF TrAc	Disable Local setpoint tracks programmer SP
<i>rmPU</i>	Setpoint rate limit units	PSEc Pm n PHr	Per second Per minute Per hour
<i>rmE</i>	Remote setpoint configuration	nonE SP LocE rmEE	Disable Remote setpoint Remote setpoint + local trim Remote trim + local setpoint

AL	Alarm configuration	Values
<p>The controller contains four 'soft' alarms, which are configured in this list. Once configured, they can be attached to a physical output as described in the alarm relay configuration list, 'RR LonF'.</p>		
AL1	Alarm 1 Type	see Table A
Ltch	Latching	no/YES/Eunt/mAn*
bLoc	Blocking	no/YES
AL2	Alarm 2 Type	see Table A
Ltch	Latching	no/YES/Eunt/mAn*
bLoc	Blocking	no/YES
AL3	Alarm 3 Type	see Table A
Ltch	Latching	no/YES/Eunt/mAn*
bLoc	Blocking	no/YES
AL4	Alarm 4 Type	see Table A
Ltch	Latching	no/YES/Eunt/mAn*
bLoc	Blocking (not if 'AL4' = 'rAL')	no/YES
Sbrt	Sensor break trip alarm latching type. Disable = process alarms inhibited when in sensor break Enable = process alarms shown when in sensor break	En Enable di 5 Disable

Table A - Alarm types	
Value	Alarm type
OFF	No alarm
FSL	PV Full scale low
FSH	PV Full scale high
dEw	PV Deviation band
dHl	PV Deviation high
dLo	PV Deviation low
LCr	Load Current low
HCr	Load Current high
FL2	Input 2 Full Scale low
FH2	Input 2 Full Scale high
LOP	Working Output low
HOP	Working Output high
LSP	Working Setpoint low
HSP	Working Setpoint high
rAL	PV Rate of change AL4 only
CTOP	CT open circuit
CTSh	CT short circuit

**\* Alarm Modes**

'no' means that the alarm will be non-latching.

'YES' means that the alarm will be latched, with automatic resetting. Automatic resetting means that if a reset is actioned before the alarm has cleared, then it will automatically reset when it clears.

'Eunt' means that the alarm is used to trip an external event. If this option is selected the front panel alarm message will not appear.





'mAn' means that the alarm will be latched, and can only be reset after it has first cleared (called 'manual reset mode').

*The following parameters apply if the **standard 8-segment programmer** is to be configured.*

<b>PFOG</b>	<b>Programmer configuration</b>	<b>Values</b>	<b>Meaning</b>
<b>PLYP</b>	Programmer type	nonE 1	Programmer disabled ( <b>factory setting</b> ) 8-segment programmer enabled
<b>HbAC</b>	Holdback	SEG PROG	Holdback is individually selectable in each segment. Holdback is applied across the whole Program.
<b>PwrF</b>	Power fail recovery	cont rmPb rSEt	Continue from last setpoint (SP) Ramp from PV to SP at last ramp rate Reset the program
<b>SrUo</b>	Starting setpoint of a program (Servo point)	toPV toSP	From the Process Value (PV) From the setpoint

*The following parameters apply if a **16-segment programmer** is to be configured.*

<b>PFOG</b>	<b>Programmer configuration</b>	<b>Values</b>	<b>Meaning</b>
<b>PLYP</b>	Programmer type	nonE 1 4 20	Programmer disabled Single program Four programs Twenty programs
<b>HbAC</b>	Holdback	SEG PROG	Holdback is individually selectable in each segment. Holdback is applied across the whole Program.
<b>PwrF</b>	Power fail recovery	cont rmPb rSEt	Continue from last setpoint (SP) Ramp from PV to SP at last ramp rate Reset the program
<b>SrUo</b>	Starting setpoint of a program (Servo point)	toPV toSP	From the Process Value (PV) From the setpoint
<b>out</b>	Programmable event outputs	no YES	Disabled Enabled
<b>SYNc</b>	Synchronisation of programs of several programmers	no YES	Disabled Enabled

Name	Description	Values	Meaning
<b>LA<sub>i</sub> LB</b>	<b>Digital input 1/2 configuration</b>		<b>Action on contact closure</b>
i d	Identity	LoG <sub>i</sub>	Logic input
Func	<p>Function of input  <i>The function is active when the input has a contact closure to the common terminal - LC</i></p> <p><i>These BCD inputs are used to select either a program number or the setpoint number according to the setting of the parameter 'bcd' in the 'INST' configuration list</i></p>	<p>nonE  mAn  rmE  SP.2  P<sub>i</sub> d.2  t<sub>i</sub> H  tunE  drA  AcAL  AccS  Locb  uP  dwn  ScrL  PAGE  run  HoLd  r-H  rES  St<sub>i</sub> P  HbAc  bcd.1  bcd.2  bcd.3  bcd.4  bcd.5  bcd.6  rmPE  SYnc  rrES  rESr  Stby  PUSL  AdU  PrGn  AmPS</p>	<p>No function  Manual mode select  Remote setpoint select  Setpoint 2 select  PID set 2 select  Integral hold  One-shot self-tune enable  Adaptive tune enable  Acknowledge alarms  Select Full access level  Keylock  Simulate pressing of the  button  Simulate pressing of the  button  Simulate pressing of the  button  Simulate pressing of the  button  Run program  Hold program  Run program (closed) / Hold (open)  Reset program  Skip to End of Current Segment, without changing the setpoint  Program holdback enabled  Least significant BCD digit  2nd BCD digit  3rd BCD digit  4th BCD digit  5th BCD digit  Most significant BCD digit  Setpoint Rate Limit Enable  Program waits at the end of the current segment  Program Run (closed) / Reset (open)  Program Reset (closed) / Run (open)  Standby - ALL control outputs turned OFF (alarm Outputs are not affected)  PV Select:  Closed = PV1 / Open = PV2  Advance to End of Segment and to Target Setpoint  Program number  Current – LB only</p>

Name	Description	Values	Meaning
<b>RR</b>	<b>Alarm relay configuration</b>		
<i>i d</i>	Identity	<i>r ELY</i>	Relay output
<i>F unc</i>	Function	<i>non E</i> <i>di G</i>	No function Digital output
<i>SEnS</i>	Digital output sense	<i>nor</i> <i>i nu</i>	Normal ( <i>output energises when TRUE, e.g. program events</i> ) Inverted ( <i>output de-energises when TRUE, e.g. alarms</i> )
The following digital events appear after ' <i>SEnS</i> '. Any one, or more, of the events can be combined on to the output (see Fig. 6-2) by selecting ' <i>YES</i> ' in the lower readout.			
<i>1 - - -</i>	Alarm 1 active	<i>YES / no</i>	<i>(- - -) = alarm type (e.g. FSL).</i> <i>If an alarm has not been configured in 'RL Conf' list, then display will differ:- e.g. Alarm 1 = 'RL 1'.</i>
<i>2 - - -</i>	Alarm 2 active	<i>YES / no</i>	
<i>3 - - -</i>	Alarm 3 active	<i>YES / no</i>	
<i>4 - - -</i>	Alarm 4 active	<i>YES / no</i>	
<i>mAn</i>	Controller in manual mode	<i>YES / no</i>	
<i>Sbr</i>	Sensor break	<i>YES / no</i>	
<i>SPAn</i>	PV out of range	<i>YES / no</i>	
<i>Lbr</i>	Loop break	<i>YES / no</i>	
<i>LdF</i>	Load failure alarm	<i>YES / no</i>	
<i>tunE</i>	Tuning in progress	<i>YES / no</i>	
<i>dcF</i>	Voltage output open circuit, or mA output open circuit	<i>YES / no</i>	
<i>rmE F</i>	PDS module measurement connection or remote input open circuit	<i>YES / no</i>	
<i>i P i F</i>	Input 1 failure	<i>YES / no</i>	
<i>nwAL</i>	New Alarm has occurred	<i>YES / no</i>	
<i>End</i>	End of setpoint rate limit, or end of program	<i>YES / no</i>	
<i>SYnc</i>	Program Synchronisation active	<i>YES / no</i>	
<i>PrG.n</i>	Programmer event output active, where 'n' = event number from 1 to 8. ( <i>Not available with 8-segment programmer.</i> )	<i>YES / no</i>	

Digital Events

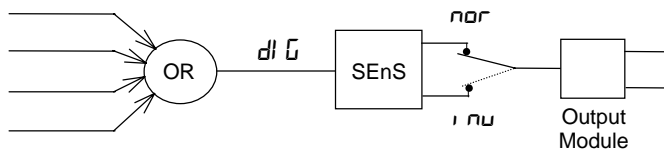

Figure 6-2 Combining several digital events on to one output

Name	Description	Values	Meaning
<b>HR</b>	<b>Comms 1 module config</b>		
<i>i d</i>	Identity of the module installed	<i>cmS</i> <i>PdS</i> <i>PdS,</i> <i>dnEt</i>	EIA-232, or 2-wire EIA-485, or 4-wire EIA-485 comms PDS retransmission PDS input DeviceNet

For ' <i>d</i> ' = ' <i>cmS</i> ' (Digital communications) use this parameter table:			
<i>Func</i>	Function	<i>mod</i> <i>El b,</i>	Modbus protocol Bisynch protocol
<i>bAud</i>	Baud Rate	<i>1200, 2400, 4800, 9600, 19.20</i> (19,200) <i>125(K), 250(K), 500(K)</i> for DeviceNet	
<i>dELy</i>	Delay - quiet period, required by some comms adaptors	<i>no</i> <i>YES</i>	No delay Delay active - 10mS
<i>The following parameters only appear if the function chosen is Modbus protocol.</i>			
<i>PrEtY</i>	Comms Parity	<i>nonE</i> <i>EuEn</i> <i>Odd</i>	No parity Even parity Odd parity
<i>rES</i>	Comms Resolution	<i>FuLL</i> <i>Int</i>	Full resolution Integer resolution

For ' <i>d</i> ' = ' <i>PdS</i> ' (PDS retransmission output) use this parameter table:			
<i>Func</i>	Function <i>i.e. Retransmitted output</i>	<i>nonE</i> <i>SP.OP</i> <i>PV.OP</i> <i>OP.OP</i> <i>Er.OP</i> <i>SP.nH</i>	No PDS function PDS setpoint retransmission PDS PV retransmission PDS output power retransmission PDS error signal retransmission PDS setpoint retransmission - no holdback

Output Scaling		
<i>VAL.L</i>		Retransmitted value low
<i>VAL.H</i>		Retransmitted Value High

Name	Description	Values	Meaning
------	-------------	--------	---------

For 'd' = 'PDS' (PDS setpoint input) use this parameter table:

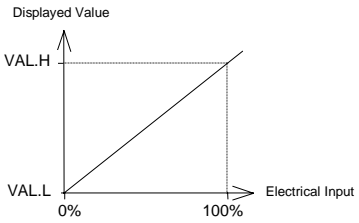
Func	Function	SP, P	PDS setpoint input
URLL			Setpoint Displayed Value - Low
URLH			Setpoint Displayed Value - High

Note: Having configured the module function as remote setpoint you must then specify the type of remote setpoint in the SP-conf list

<b>JR</b>	<b>Comms 2 module config</b>		
As per Comms 1 module configuration			

Name	Description	Values	Meaning
<b>IA/IC<sup>(1)</sup></b>	<b>Module 1 configuration</b>		
<b>d</b>	Identity of module installed  <i>(1) If a dual-, or triple-, channel module is installed then the list headers Ib and IC also appear</i>	<i>nonE</i> <i>rELY</i> <i>dcOP</i>  <i>LoG</i> <i>LoG,</i> <i>SSr</i> <i>dcrE</i> <i>dcOP</i> <i>SGSU</i>	Module not fitted Relay output DC output isolated and non-isolated Logic/PDS output Logic input Triac output DC retransmission (isolated) Isolated DC output Transducer power supply

For 'd' = 'rELY', 'LoG', or 'SSr' use this parameter table:			
<b>Func</b>	Function  <i>(Only Channels IA and IC can be Heating, or Cooling)</i>  <i>(Only if 'd' = 'LoG')</i> <i>(Only if 'd' = 'LoG')</i>	<i>nonE</i> <i>dlG</i> <i>HEAT</i> <i>COOL</i> <i>uP</i> <i>dwn</i> <i>SSr.1</i> <i>SSr.2</i>	Function disabled Digital output function Heating output Cooling output Open motorised valve Close motorised valve PDS mode 1 heating PDS mode 2 heating
<b>VAL.L</b>			% PID demand signal giving minimum output – ' <b>Out.L</b> '
<b>VAL.H</b>			% PID demand signal giving maximum output – ' <b>Out.H</b> '
<b>Out.L</b>			Minimum average power
<b>Out.H</b>			Maximum average power
<b>SEN5</b>	Sense of output <i>(Only if 'Func' = 'dlG')</i>	<i>nor</i>  <i>nu</i>	Normal ( <i>output energises when TRUE, e.g. program events</i> ) Inverted ( <i>output de-energises when TRUE, e.g. alarms</i> )
<b>Notes:</b> <ol style="list-style-type: none"> <li>When '<b>SEN5</b>' appears, then further parameters are available. These are identical to those in the '<b>RA CONF</b>' list on Page 6-14.</li> <li>If a Transducer Power Supply is fitted, the '<b>SEN5</b>' parameter selects the output voltage. <i>nor</i> = 5V, <i>nu</i> = 10V</li> <li>A Transducer Power Supply does not provide any calibration facility and is simply a 5 or 10V power supply.</li> <li>To invert a PID output, the Val. H can be set below the Val.L</li> </ol>			



Name	Description	Values	Meaning
------	-------------	--------	---------

For 'd' = 'dCOP', 'dcrE', or 'dCOP' use this parameter table:

Func	Function	nonE	Function disabled
		HEAT	Heating output
		COOL	Cooling output
		PV	Retransmission of PV
		wSP	Retransmission of setpoint
		Err	Retransmission of error signal
		OP	Retransmission of OP power
VAL.L	%PID, or Retransmission Value 		% PID, or Retrans'n Value, giving minimum output
VAL.H			% PID, or Retrans'n Value, giving maximum output
unit			volts = Volts, mA = milliamps
Out.L			Minimum electrical output
Out.H			Maximum electrical output

For 'd' = 'LOG' (i.e logic input) use the **LA Conf** list on Page 6-13.

2A/b/C	Module 2 configuration		
As per module 1 configuration, but excluding the 'SSr.1', 'SSr.2' functions.			
d	Identity of module installed. As per module 2 plus:	tPSU Pot.	Transmitter power supply Potentiometer input

For 'd' = 'Pot.' (i.e. potentiometer input module) use this parameter table:

Func	Function	nonE rSP Fwd. rOPh rOPL UPoS	Function disabled Remote Setpoint Feedforward input Remote OP power max. Remote OP power min. Motorised valve position
VAL.L	Displayed value 		Displayed value low equivalent to 0% potentiometer position
VAL.H			Displayed value high equivalent to 100% potentiometer position

<b>3A/b/C</b>	<b>Module 3 configuration</b>	
As per module 2 configuration, plus 'd' = 'dC, P'		

For 'd' = 'dC, P' use this parameter table.  
**THIS INCLUDES THE SECOND PV FUNCTIONS**

<i>F<sub>UNC</sub></i>	Function	<i>nonE</i> <i>rSP</i> <i>FwdI</i> <i>rOPh</i> <i>rOPL</i> <i>H<sub>i</sub></i> <i>L<sub>o</sub></i> <i>FEn</i>  <i>SEL</i>  <i>trAn</i>	Function disabled Remote Setpoint Feedforward input Remote OP power max. Remote OP power min. PV = The highest of 'P. I, or 'P.2' PV = The lowest of 'P. I, or 'P.2' Derived function, where $PV = (F. I \times P. I) + (F.2 \times P.2)$ . 'F. I' and 'F.2' are scalars which are found in 'P-L, St' of Operator Level Select 'P. I, or 'P.2' via Comms, front panel buttons, or a digital input Transition of control between 'P. I and 'P.2'. The transition region is set by the values of 'L <sub>o</sub> P' and 'H <sub>i</sub> P', which are found in 'P-L, St' of Operator Level. PV = 'P. I below 'L <sub>o</sub> P' PV = 'P.2 above 'H <sub>i</sub> P'
<i>i nPE</i>	Input type		Refer to 'P COnF' for all types, + the following: <i>H<sub>i</sub> I n</i> High Impedance (range = 0 to 2 volt)
<i>CJC</i>	Cold Junction Compensation	<i>OFF</i> <i>Auto</i> <i>0°C</i> <i>45°C</i> <i>50°C</i>	No cold junction compensation Automatic internal compensation 0°C external reference 45°C external reference 50°C external reference
<i>i mP</i>	Sensor Break Impedance	<i>OFF</i>  <i>Auto</i> <i>H<sub>i</sub></i> <i>H<sub>i</sub> H<sub>i</sub></i>	Disabled (applies to any input) <b>Caution:</b> <b>If sensor break is disabled the controller will not detect open circuit faults</b> Factory set Impedance of input > 15KΩ Impedance of input > 30KΩ

**Linear Input Scaling** – The next four parameters only appear if a linear input is chosen.

<i>i nPL</i>		Input value low
<i>i nPH</i>		Input value high
<i>UAL L</i>		Displayed value low
<i>UAL H</i>		Displayed value high

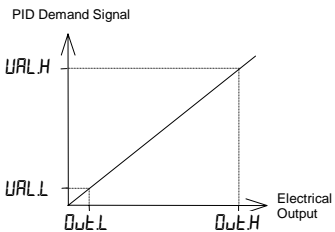
Name	Description	Values	Meaning
<b>4R</b>	<b>Module 4 configuration</b>		
<b>Note: This option is not available on controllers from 01 Jan-04</b>			
<b>id</b>	Identity of module installed	<b>HCS</b>	High Current Switch
<b>Func</b>	Function	<b>none</b> <b>dl G</b> <b>HEAT</b> <b>COOL</b>	Function disabled Digital output function Heating output Cooling output
<b>URLL</b>			% PID demand signal giving minimum output – ‘OutL’
<b>URLH</b>			% PID demand signal giving maximum output – ‘OutH’
<b>OutL</b>			Minimum electrical output
<b>OutH</b>			Maximum electrical output
<b>SEN5</b>	Sense of output (Only if <b>Func</b> = ‘dl G’)	<b>nor</b> <b>inv</b>	Normal (output energises when TRUE, e.g. program events) Inverted (output de-energises when TRUE, e.g. alarms)
<p>When ‘SEN5’ appears, then further parameters are available. These are identical to those in the ‘RR Conf’ list on Page 6-14.</p>			

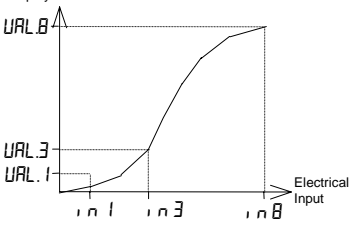
<b>Custom</b>	<b>8-point Custom Linearisation <sup>(1)</sup></b>		
<b>in 1</b>	Displayed Value	Custom input 1	
<b>URL 1</b>		Linearisation Value representing <b>in 1</b>	
<b>in 8</b>		Custom input 8	
<b>URL B</b>		Linearisation Value representing <b>in 8</b>	

**Note:**

1. Custom Linearisation is only available when ‘RR-Conf’ or ‘P- Conf’ list has ‘nPE’ set to ‘mUL’, or ‘mAL’, or ‘UL’.
2. The values and inputs must be continuously increasing or decreasing

Name	Description	Values	Meaning
------	-------------	--------	---------

CAL		Calibration		
<p><i>In this mode you can</i></p> <ol style="list-style-type: none"> <li>1. Calibrate the instrument using a mV source - rCAL or ref source cal.</li> <li>2. Offset the calibration to account for errors in actual sensor measurement and a ref sensor - ULCAL or user calibration</li> <li>3. Return to factory set calibration - FACL or factory set calibration.</li> </ol>				
rCAL	Calibration point	nonE	No calibration	▶ Goto User calibration table- See also chapter 7
		PU	Calibrate main Process Value input.	
		PU2	Calibrate DC input, or PV 2.	
				▶ Go to DC Output Calibration table
		1RH	Calibrate DC output high - Module 1	
		1RL	Calibrate DC output low - Module 1	
		2RH	Calibrate DC output high - Module 2	
		2RL	Calibrate DC output low - Module 2	
3RH	Calibrate DC output high - Module 3			
3RL	Calibrate DC output low - Module 3			

INPUT CALIBRATION			
For 'CAL' = 'PU', or 'PU2', the following parameters apply.			
PU	PV Calibration Value	Idle	Idle
		mUL	Select 0mV as the calibration point
		mUH	Select 50mV as the calibration point
		U0	Select 0Volt as the calibration point
		U10	Select 10V as the calibration point
		CJC	Select 0°C CJC calibration point
		rtD	Select 400Ω as the calibration point
		HI 0	High impedance: 0Volt cal'n point
		HI 10	High impedance: 1.0 Volt cal'n point
		FACL	Restore factory calibration
GO	Start calibration Select 'YES' with <input type="triangle-up"/> or <input type="triangle-down"/> Wait for calibration to complete.	no	Waiting to calibrate PV point
		YES	Start calibration
		busy	Busy calibrating
		done	PV input calibration completed
		FAIL	Calibration failed

**Note.** When a DC input module is installed for the first time, or there is a requirement to change one, then the microprocessor in the controller needs to read the factory calibration data stored in the module. Select 'FACL' as the calibration value. Step to 'GO' and start calibration.

<b>DC Output Calibration</b>			
<i>The following parameters apply to DC output modules ie for <math>r\text{-}cRL = 1AH</math> to <math>3AL0</math></i>			
$cRLH$	Output Calibration High	0	0 = Factory set calibration. Trim value until output = 9V, or 18mA
$cRL L$	Output Calibration Low	0	0 = Factory set calibration. Trim value until output = 1V, or 2mA

<b>User calibration</b>		
UCAL	User calibration enable	Yes/no
$PE 1L$	Low calibration point for Input 1	The factory calibration point at which the low point offset was performed.
$PE 1H$	High calibration point for Input 1	The factory calibration point at which the high point offset was performed.
$OF 1L$	Offset Low for Input 1	Calculated offset, in display units.
$OF 1H$	Offset High for Input 1	Calculated offset, in display units.
$PE 2L$	Low calibration point for Input 2	The factory calibration point at which the low point offset was performed.
$PE 2H$	High calibration point for Input 2	The factory calibration point at which the high point offset was performed.
$OF 2L$	Offset Low for Input 2	Calculated offset, in display units.
$OF 2H$	Offset High for Input 2	Calculated offset, in display units.

Name	Description	Values	Meaning
$PASS$	Password configuration		
$ACCP$	FuLL or Edit level password		
$cnFP$	Configuration level password		







**Note:-** When passwords are changed please make a note of the new numbers

$EXIT$	Exit configuration	no/YES	
--------	--------------------	--------	--

## CONFIGURATION EXAMPLES

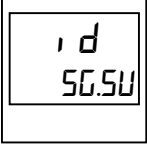



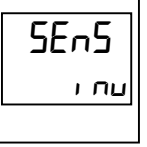





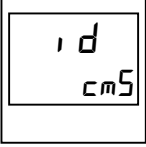

### Transducer Power Supply





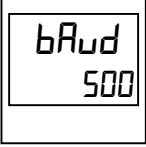

To configure the choice of output voltage:-

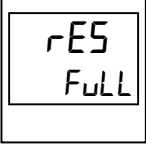
Do This	The Display You Should See	Additional Notes
1. Press  as many times as necessary to select the slot position in which the transducer power supply is fitted		The transducer power supply can be fitted in slot positions 1 and 2.  The display will show <i>IA</i> or <i>IB</i> accordingly
2. Press  to read the identity of the module		This is read only where: <i>50.5U</i> = Transducer Power Supply
3. Press  (twice) to read 'SEnS'  4. Press  and  to select ' <i>nu</i> ' or ' <i>nr</i> '		<i>nu</i> = 10Vdc <i>nr</i> = 5Vdc  The Transducer Power supply uses existing software written for digital modules. A list of parameters follow which are not applicable to this module.

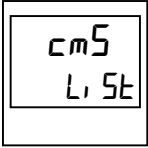
### DeviceNet

To configure Function, Baud Rate, Resolution and Node Address:-

Do This	The Display You Should See	Additional Notes
1. Press  as many times as necessary to select 'HA'		This is the position in which the DeviceNet module is fitted
2. Press  to read 'd'		If the module is present 'd' = 'cm5' (digital communications) or 'none' if the module is not present
3. Press  to read 'Func'		If the DeviceNet module is fitted 'Func' = 'dnEt' and will be read only
4. Press  to read 'bAud' 5. Press  and  to select the baud rate		Baud rate can be set to 125(K), 250(K) or 500(K)
6. Press  to read 'rES' 7. Press  and  to select 'FULL' or 'nt'		FULL - the decimal point position is implied, eg 100.1 is transmitted as 1001. 'nt' - rounded to the nearest integer value

Node Address is set up in Operator or Full Access level. Select either of these levels, then:-		
<p>8. Press  as many times as necessary to select 'cm5'</p>		
<p>9. Press  to read 'Addr'</p> <p>10. Press  and  to select the address</p>		<p>Valid addresses are from 0 - 63</p>
<p>11. Press  to read 'nw.5t'</p>		<p>Indicates the network status:-</p> <p>'run' = network connected and operational</p> <p>'rdy' = network connected but not operational</p> <p>'OFFL' = network not connected</p>





## Chapter 7 USER CALIBRATION

This chapter has five topics:

- WHAT IS THE PURPOSE OF USER CALIBRATION?
- USER CALIBRATION ENABLE
- OFFSET CALIBRATION
- TWO POINT CALIBRATION
- CALIBRATION POINTS AND CALIBRATION OFFSETS

To understand how to select and change parameters in this chapter you will need to have read Chapter 2 - *Operation*, Chapter 3- *Access Levels* and Chapter 6 - *Configuration*.

### WHAT IS THE PURPOSE OF USER CALIBRATION?

The basic calibration of the controller is highly stable and set for life. User calibration allows you to offset the 'permanent' factory calibration to either:

1. Calibrate the controller to the your reference standards.
2. Match the calibration of the controller to that of a particular transducer or sensor input.
3. Calibrate the controller to suit the characteristics of a particular installation.
4. Remove long term drift in the factory set calibration.

User calibration works by introducing a single point, or two-point, offset onto the factory set calibration.

## USER CALIBRATION ENABLE

The User calibration facility must first be enabled in configuration level by setting the parameter 'UCAL' in the input conf list to 'YES'. This will make the User calibration parameters visible in Operator 'FULL' level.

Select configuration level as shown in Chapter 6, *Configuration*.

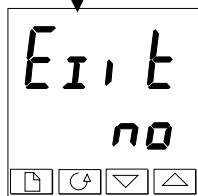
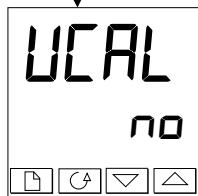

### The Calibration Configuration List



Press  until you reach the 'CAL-CONF' list.

Press  until you reach 'UCAL'.



### User Calibration Enable

Use  or  to select:

- YES: Calibration enable
- no: Calibration disabled

Press  and  together to go to the E1,t display.

### Exit configuration

Use  or  to select 'YES' to return to Operator level.

## OFFSET CALIBRATION

Offset calibration is used to apply a single fixed offset over the full display range of the controller.

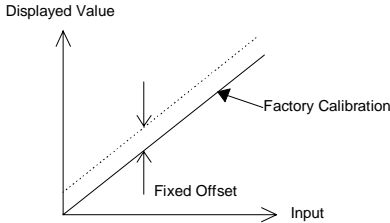

To calibrate, proceed as follows:

1. Connect the input of the controller to the source device to which you wish to calibrate.
2. Set the source to the desired calibration value.
3. The controller will display the current measurement of the value.
4. If the displayed value is correct, then the controller is correctly calibrated and no further action is necessary. If it is incorrect, then follow the steps shown below.

Select 'FULL' access level, as described in Chapter 3.

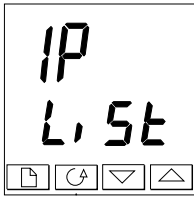

### Input list header

Press until you reach the input list header.



Press until you reach the 'CAL' display.

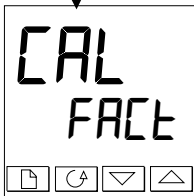

### Calibration type

- **FACT:** Factory Calibration
- **USER:** User Calibration

Use or to select 'FACT'.

Selecting 'FACT' reinstates the factory calibration and allows the application of a single fixed offset.



Press

*continued  
on the next page*

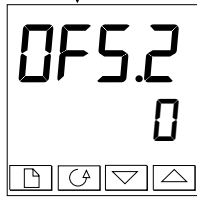
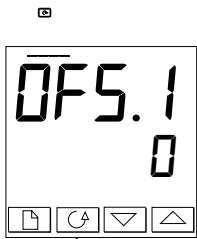

See table on the right for additional parameters.

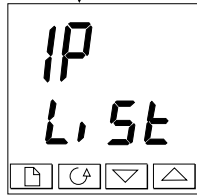

**Set Offset 1**

Use or to set the offset value of Process Value 1 (PV1). The offset value is in display units.

Press

**Set Offset 2**

Use or to set the offset value of Process Value 2 (PV2), *if configured*. The offset value is in display units.

Press

The table below shows the parameters which appear after 'OFS.2'. These are all read only values and are for information.

Press to step through them.

mU.1	IP1 measured value (at terminals)
mU.2	IP2 measured value (at terminals), if DC input in Module 3 position
CJC.1	IP1 Cold Junction Compensation
CJC.2	IP2 Cold Junction Compensation
L.1	IP1 Linearised Value
L.2	IP2 Linearised Value
PUSL	Shows the currently selected input

If you do not want to look at these parameters, then press and this returns you to the 'IP L, St' header.

To protect the calibration against unauthorised adjustment, return to Operator level and make sure that the calibration parameters are hidden. Parameters are hidden using the 'Edit' facility described in Chapter 3, *Access Levels*.

## TWO-POINT CALIBRATION

The previous section described how to apply a offset, or trim, calibration, which applies a fixed offset over the full display range of the controller. A two-point calibration is used to calibrate the controller at two points and applies a straight line between them. Any readings above, or below, the two calibration points will be an extension of this straight line. For this reason it is best to calibrate with the two points as far apart as possible.

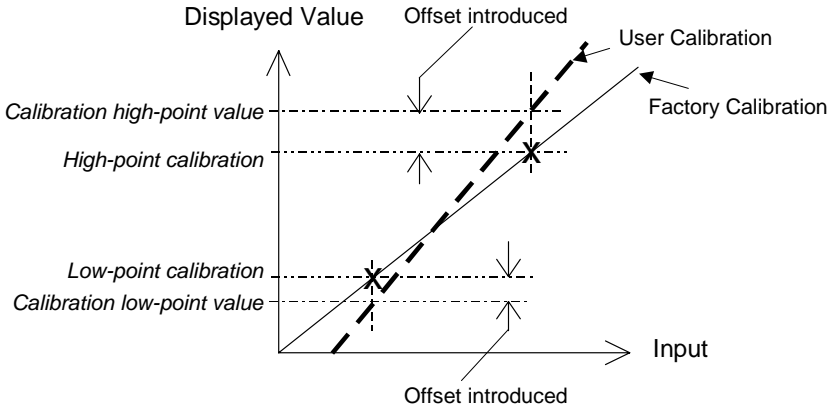

Proceed as follows:

1. Decide upon the low and high points at which you wish to calibrate.
2. Perform a two point calibration in the manner described below.

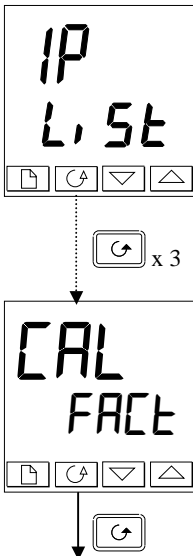

### Input list header

Press until you reach the input list header, 'PL St'.

Press until you reach the 'CAL' display.

### Calibration type

- **FACT:** Factory Calibration
- **USER:** User Calibration

Use or to select 'USER'.

Selecting 'USER' enables two-point calibration.

[If two-point calibration is unsatisfactory, select 'FACT' to return to the factory set calibration.]

Press

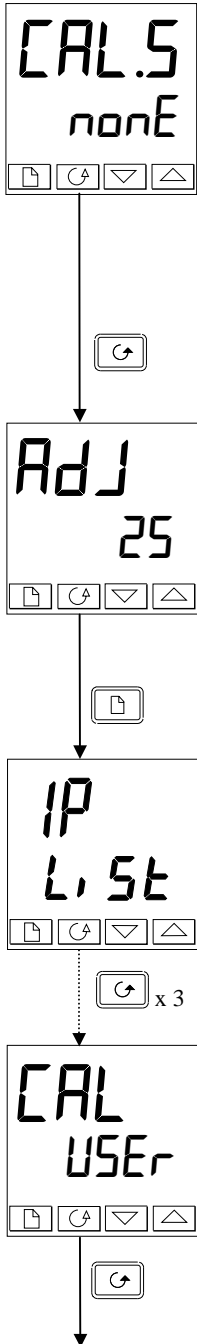

**Select Low-point Calibration**

This is the Calibration Status display. This display shows that no input is selected for calibration.

- none: No selection
- , P 1L: Input 1 (PV1) calibration low-point selected
- , P 1H: Input 1 (PV1) calibration high-point selected
- , P 2L: Input 2 (PV2) calibration low-point selected
- , P 2H: Input 2 (PV2) calibration high-point selected

Use to select the parameter for the Low Calibration point of Input 1, ' P 1L '.

Press

**Adjust low-point calibration**

This is the display for adjusting the Low Calibration point of Input 1. The lower readout is a live reading of the process value, which changes as the input changes.

Make sure that the calibration source is connected to the terminals of Input 1, switched on and feeding a signal to the controller. It should be set to the desired low-point calibration value. If the lower readout does not show this value, then use to adjust the reading to the required value.

Press to return to the ' P-L, St ' header.

To perform the High-point Calibration, repeat the above procedure, selecting ' P 1H ' in the 'CAL.5' display for adjustment.

Press three times.

**Calibration type**

'USER' was selected for the Low-point Calibration, and has remained selected.

Press

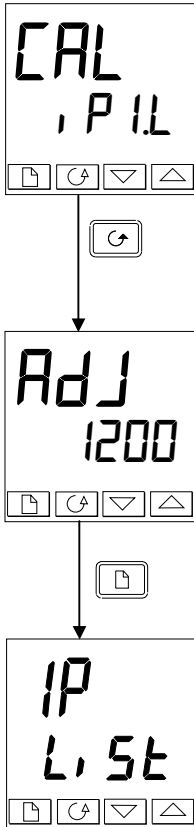

### Select High-point Calibration

This is the Calibration Status display, again.

Use / to select the parameter for the High-point Calibration of Input 1, 'P1H'.

Press

### Adjust High-point Calibration

This is the display for adjusting the High Calibration point of Input 1. The lower readout is a live reading of the process value, which changes as the input changes.

Feed the desired high-point calibration signal to the controller, from the calibration source. If the lower readout does not show this value, then use / to adjust the reading to the required value.

Press to return to the 'P-L, St' header.

To protect the calibration against unauthorised adjustment return to Operator level and make sure that the calibration parameters are hidden. Parameters are hidden using the 'Ed, t' facility described in Chapter 3.

To perform a User Calibration on Input 2, proceed as with Input 1 above, except that when 'CAL5-none' appears, press / until 'CAL5-P2L' is obtained, then proceed as with Input 1. Repeat the procedure for 'P2H'.





## CALIBRATION POINTS AND CALIBRATION OFFSETS

If you wish to see the points at which the User calibration was performed and the value of the offsets introduced, then these are shown in Configuration, in 'CAL-CONF'.

The parameters are:

Name	Parameter description	Meaning
PE1L	Low calibration point for Input 1	The factory calibration point at which the low point offset was performed.
PE1H	High calibration point for Input 1	The factory calibration point at which the high point offset was performed.
OF1L	Offset Low for Input 1	Calculated offset, in display units.
OF1H	Offset High for Input 1	Calculated offset, in display units.
PE2L	Low calibration point for Input 2	The factory calibration point at which the low point offset was performed.
PE2H	High calibration point for Input 2	The factory calibration point at which the high point offset was performed.
OF2L	Offset Low for Input 2	Calculated offset, in display units.
OF2H	Offset High for Input 2	Calculated offset, in display units.

**Note:** The value of each of the parameters in the above table may also be altered by using the   buttons.

# Appendix A

## UNDERSTANDING THE ORDERING CODE

The 2408 and 2404 controllers have a modular hardware construction, which accepts up to three plug-in Input/Output modules and two communications modules to satisfy a wide range of control requirements. Two digital inputs and an optional alarm relay form part of the fixed hardware build.

The ordering code is in two parts. The hardware coding and an optional configuration coding. The hardware coding specifies the basic build of the controller and the plug-in modules that are fitted.

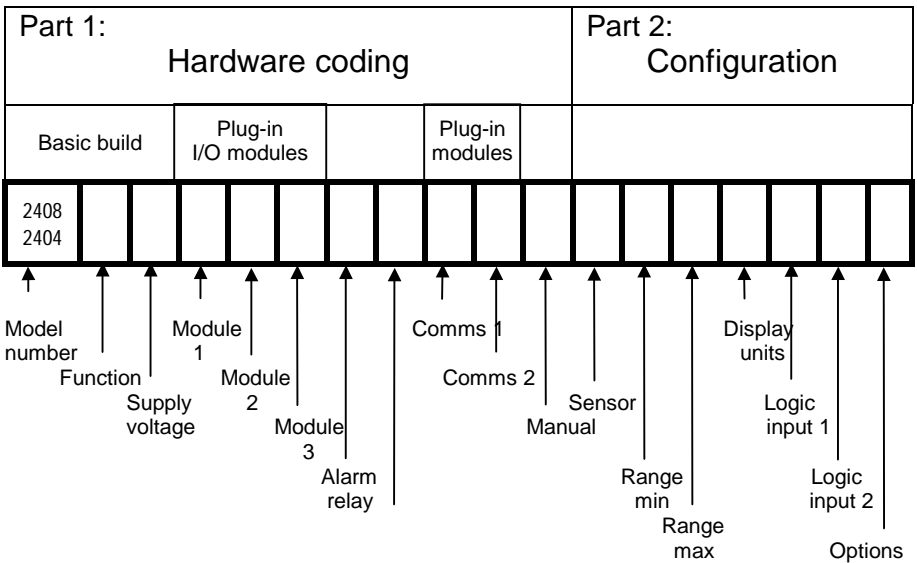

The controller may have been ordered with just the hardware build specified, or with configuration included. This is indicated by the ordering code on the side of the controller.

Part 1A: Hardware coding			
Basic build		Plug-in modules	
Model number	Function	Supply voltage	Module 1
2408	CC	VH	LH

▶ Continued next page

Model Number	
2408	1/8 DIN Controller
2404	1/4 DIN Controller
Profibus units	
2408f	1/8 DIN Controller
2404f	1/4 DIN Controller

Function	
Standard PID control	
CC	Controller
CG	1 x 8 seg prog
CP	1 x 16 seg prog
P4	4 x 16 seg prog
CM	20 x 16 seg prog
	Note 1
On/Off control	
NF	Controller only
NG	1 x 8 seg prog
NP	1 x 16 seg prog
N4	4 x 16 seg prog
NM	20 x 16 seg prog
Motorised valve control	
VC	Valve positioner (VP)
VG	1 x 8 seg prog
VP	1 x 16 seg prog
V4	4 x 16 seg prog
VM	20 x 16 seg prog
	Note 1

Supply voltage	
VH	85 to 264Vac
VL	20 to 29Vac/dc

Module 1	
XX	Not fitted
Relay:	2-pin
R2	Fitted unconfigured
RH	PID heating
RU	Valve raise output
Relay: change-over	
R4	Fitted unconfigured
YH	PID heating
RP	Valve raise (note 6)
<i>Or Alarm 1: select from table A</i>	
Logic: (Non-isolated)	
L2	Fitted unconfigured
LH	Heating output
M1	PDS heater break detect (note 2)
M2	PDS current monitoring (note3)
Logic: (isolated)	
LO	Single logic output
Triac	
T2	Fitted unconfigured
TH	Heating output
TU	Valve raise output
DC control (isolated)	
D4	Fitted unconfigured
H6	0-20mA PID heating
H7	4-20mA PID heating
H8	0-5V PID heating
H9	1-5V PID heating
HZ	0-10V PID heating
Digital I/O (unconfigured)	
TK	Triple contact input
TL	Triple logic input
TP	Triple logic output
Dual relay	
RR	Fitted unconfigured
RD	PID heat + PID cool
RM	Valve raise and lower
Dual triac	
TT	Fitted unconfigured
TD	PID heat + PID cool
TM	Valve raise and lower
Logic + relay	
LR	Fitted unconfigured
LD	PID heat + PID cool
QC	Mode 2 + cool
Logic + triac	
LT	Fitted unconfigured
GD	PID heat + PID cool
QD	Mode 2 + cool
Transducer P5	
G3	5Vdc
G5	10Vdc

Table A : Alarm relay functions	
FH	High alarm
FL	Low alarm
DB	Deviation band
DL	Low dev. alarm
DH	High dev alarm

Table B : DC retransmission	
D6	Fitted unconfigured
First character	
V-	PV retrans
S-	Setpoint retrans
O-	Output retrans
Z-	Error retrans
Second character	
-1	0-20mA
-2	4-20mA
-3	0-5V
-4	1-5V
-5	0-10V

continued



Part 1B: Hardware coding						
Plug-in modules		Alarm relay		Plug-in modules		Manual
Module 2	Module 3			Comms 1	Comms 2	
RC	FL	FH		YM	TS	ENG

Module 2	
XX	Not fitted
<b>Relay: 2-pin</b>	
R2	Fitted unconfigured
RC	Cooling output
RW	Valve lower output
<b>Relay: change-over</b>	
R4	Fitted unconfigured
YC	Cooling Output
RL	Valve lower (note 6)
PO	Program event output 1 (note 7)
PE	Program END segment
<i>Or Alarm 2: select from table A</i>	
<b>Dual relay</b>	
RR	Fitted unconfigured
PP	Program events 1 & 2 (note 7)
<b>Logic (non-isolated)</b>	
L2	Fitted unconfigured
LC	PID cooling
<b>Logic (isolated)</b>	
LO	Single logic output
<b>Triac</b>	
T2	Fitted unconfigured
TC	PID cooling
TW	Valve lower output
<b>DC control isolated</b>	
D4	Fitted unconfigured
O6	0-20mA PID cooling
C7	4-20mA PID cooling
O8	0-5V PID cooling
O9	1-5V PID cooling
CZ	0-10V PID cooling
<b>Digital I/O (unconfigured)</b>	
TK	Triple contact input
TL	Triple logic input
TP	Triple logic output
<b>Power supply</b>	
MS	24Vdc transmitter
<b>DC retran (isolated)</b>	
<i>Select from table B</i>	
<b>Potentiometer input</b>	
VU	Fitted unconfigured
VS	Valve position feedback
VR	Setpoint input
<b>Transducer PSU</b>	
G3	5Vdc
G5	10Vdc

Module 3	
XX	Not fitted
<b>Relay: 2-pin</b>	
R2	Fitted unconfigured
<b>Relay: change-over</b>	
R4	Fitted unconfigured
PO	Program event 4 (note 7)
PE	Program END output
<i>Or Alarm 3 select from table A</i>	
<b>Logic (non-isolated)</b>	
L2	Fitted unconfigured
<b>Logic (isolated)</b>	
LO	Single logic output
<b>Triac</b>	
T2	Fitted unconfigured
<b>Dual relay</b>	
RR	Fitted unconfigured
PP	Program event 4 & 5 (note 7)
<b>Digital I/O (unconfigured)</b>	
TK	Triple contact input
TL	Triple logic input
TP	Triple logic output
<b>Power supply</b>	
MS	24V transmitter
<b>DC remote input</b>	
D5	Fitted unconfigured
W2	4 to 20mA setpoint
W5	0 to 10V setpoint
WP	Second PV input
<b>DC retran (isolated)</b>	
<i>Select from table B</i>	
<b>Potentiometer input</b>	
VU	Fitted unconfigured
VS	VP feedback
VR	Setpoint input
<b>Transducer PSU</b>	
G3	5Vdc
G5	10Vdc

Comms 1	
XX	None
<b>2-wire EIA-485</b>	
Y2	Fitted unconfigured
YM	Modbus protocol
YE	EI Bisynch protocol (note 1)
<b>RS-232</b>	
A2	Fitted unconfigured
AM	Modbus protocol
AE	EI Bisynch protocol (note 1)
<b>4-wire RS-485</b>	
F2	Fitted unconfigured
FM	Modbus protocol
FE	EI Bisynch protocol (note 1)
<b>PDS output</b>	
M7	Fitted unconfigured
PT	PV retransmission
TS	Setpoint retrans
OT	Output retrans
<b>Profibus module</b>	
PB	High speed RS485
<b>DeviceNet</b>	
DN	DeviceNet

Comms 2	
XX	Not fitted
<b>PDS input</b>	
M6	Fitted unconfigured
RS	Setpoint input
<b>PDS output</b>	
M7	Fitted unconfigured
PT	PV retransmission
TS	Setpoint retrans
OT	Output retrans

Alarm relay	
XX	Not fitted
<b>Alarm 4 relay</b>	
RF	Fitted unconfigured
<i>Table A alarm options plus:</i>	
RA	Rate of change
<b>PDS alarms</b>	
LF	Heater break detect
HF	Current monitor heater brk
SF	Current monitor SSR fail
PO	Program event 7 (note 7)
PE	Program END output

Manual	
XXX	No manual
ENG	English
FRA	French
GER	German
NED	Dutch
SPA	Spanish
SWE	Swedish
ITA	Italian

Hardware coding	Part 2: Configuration				Continued next page 
	Sensor input	Range min	Range max	Display Units	
	K	See note 4 0   1000		C	

Sensor input	Range min & max		
<b>Standard sensor inputs</b>	°C	°F	
J	J thermocouple	-210 to 1200	-340 to 2192
K	K thermocouple	-200 to 1372	-325 to 2500
T	T thermocouple	-200 to 400	-325 to 750
L	L thermocouple	-200 to 900	-325 to 650
N	N thermocouple	-250 to 1300	-418 to 2370
F	Type R - Pt13%Ph/Pt	-50 to 1768	-58 to 3200
S	Type S - Pt10%Rh/Pt	-50 to 1768	-58 to 3200
E	Type B - Pt30%Rh/Pt6%Rh	0 to 1820	32 to 3308
F	Platinel II	0 to 1369	32 to 2496
Z	RTD/PT100	-200 to 850	-325 to 1562
<b>Process inputs</b>			
F	+/- 100mV	0 to 9999	
Y	0-20 mA Linear	0 to 9999	
A	4-20 mA Linear	0 to 9999	
V	0-5V DC Linear	0 to 9999	
C	1-5V DC Linear	0 to 9999	
V	0-10V DC Linear	0 to 9999	
<b>Factory downloaded input</b>			
C	*Type C W5%Re/W26%Re (Hoskins)*	0 to 2319	32 to 4200
E	Type D - W3%Re/W25%Re	0 to 2399	32 to 4350
E	E thermocouple	-270 to 1000	-450 to 1830
1	Ni/Ni18%Mo	0 to 1399	32 to 2550
2	Pt20%Rh/Pt40%Rh	0 to 1870	32 to 3398
3	W/W26%Re (Englehard)	0 to 2000	32 to 3632
4	W/W26%Re (Hoskins)	0 to 2010	32 to 3650
5	W5%Re/W26%Re (Englehard)	10 to 2300	50 to 4172
6	W5%Re/W26%Re (Bucose)	0 to 2000	32 to 3632
7	Pt10%Rh/Pt40%Rh	200 to 1800	392 to 3272
8	Exergen K80 I.R. pyrometer	-45 to 650	-50 to 1200

Display Units	
C	Celcius
F	Fahrenheit
K	Kelvin
X	Linear input

continued	Part 2: Configuration						
	Digital input 1	Digital input 2	Control	Power feedback	Cooling	Buttons	Program
▶	AM	S2	XX	XX	XX	MD	XX

Digital inputs 1 & 2			
XX	Disabled	AT	Adaptive tune enable
AM	Manual select	FA	Select full access level
SR	Remote setpoint select	RB	Simulates UP button
S2	Second setpoint select	LB	Simulates DOWN button
EH	Integral hold	SB	Simulates SCROLL button
AC	Alarm acknowledge	PB	Simulates PAGE button
RP	Setpoint rate limit enable	B1	Least sig. BCD dig.
RN	Run program	B2	2nd BCD digit
HO	Hold program	B3	3rd BCD digit
RE	Reset program	B4	4th BCD digit
RH	Run/hold program	B5	5th BCD digit
KL	Keylock	B6	Most sig. BCD digit
NT	Run/Reset program	SY	Standby - ALL ops OFF
TN	Reset/Run program	SG	Skip segment (without changing SP)
HB	Prog. holdback enable	SC	Program synch.
P2	PID2 select	PV	Select PV2
ST	One-shot tune enable	AG	Advance to end of segment (& step to target setpoint)
		M5	CTX (mode 5) (input 2 only)

Options	
<b>Control action</b>	
XX	Reverse acting (standard)
DP	Direct acting PID control
<b>Power feedback</b>	
XX	Enabled on logic, relay & triac heating
PD	Feedback disabled
<b>Cooling options</b>	
XX	Linear cooling
CF	Fan cooling
CW	Water cooling
CL	Oil cooling
CO	On/off cooling
<b>Front panel buttons</b>	
XX	Enabled
MD	Auto/man button disabled
MR	Auto/man & run/hold disabled
RD	Run/hold button disabled
<b>Programmer time units</b>	
XX	Dwell & ramp in minutes
HD	Dwell time in hours
HR	Ramp rate in units/hour

The example given in the coding is for 2408 PID controller, 85 to 264 Vac, logic heating, relay cooling, low alarm relay, high alarm relay, RS485 Modbus comms, PDSIO setpoint retransmission, type K thermocouple, 0 to 1000°C, Auto/manual select, second setpoint select, manual button disabled.

**Notes:**

1. Not available with profibus controllers
  2. PDS heater break detect will transmit the power demand to a TE10S solid state relay and read back a heater break alarm
  3. PDS current monitoring will transmit the power demand signal to a TE10S solid state relay and read back load current and open and short circuit alarms
  4. Setpoint limits: include the decimal position required in the displayed value. Up to one for temperature inputs, up to two for process inputs
  5. An external 1% current sense resistor is supplied as standard. If greater accuracy is required, a 0.1% 2.49 $\Omega$  can be ordered as part number SUB2K/249R.1
  6. Only available with Profibus controller
  7. Not available with 8 segment programmer
- 
- **PDS** is a proprietary technique for bi-directional transmission of analogue and digital data between instruments.
    - Mode 1: provides logic heating to a TE10S (fitted with option PDS1) solid state relay with feedback of a general load fault alarm.
    - Mode 2: provides logic heating to a TE10S (fitted with option PDS2) solid state relay with feedback of load current and two alarms: solid state relay failure and heater circuit failure.
  - **Range min and Range max:** Thermocouple and RTD sensor inputs will always display over the full operating range shown in Sensor input table. For these inputs, the values entered here are the low and high setpoint limits. For process inputs, the values are the display scaling, corresponding to the minimum and maximum input values.

## SAFETY and EMC INFORMATION

Please read this section carefully before installing the controller

This controller is intended for industrial temperature and process control applications when it will meet the requirements of the European Directives on Safety and EMC. Use in other applications, or failure to observe the installation instructions of this handbook may impair the safety or EMC protection provided by the controller. It is the responsibility of the installer to ensure the safety and EMC of any particular installation.

### Safety

This controller complies with the European Low Voltage Directive 73/23/EEC, amended by 93/68/EEC, by the application of the safety standard EN 61010.

### Electromagnetic compatibility

This controller conforms with the essential protection requirements of the EMC Directive 89/336/EEC, amended by 93/68/EEC, by the application of a Technical Construction File. This instrument satisfies the general requirements of an industrial environment as described by EN 50081-2 and EN 50082-2. For more information on product compliance refer to the Technical Construction File.

## SERVICE AND REPAIR

This controller has no user serviceable parts. Contact your nearest Eurotherm Controls agent for repair.

### **Caution: Charged capacitors**

Before removing an instrument from its sleeve, disconnect the supply and wait at least two minutes to allow capacitors to discharge. Failure to observe this precaution will expose capacitors that may be charged with hazardous voltages. In any case, avoid touching the exposed electronics of an instrument when withdrawing it from the sleeve.

### Electrostatic discharge precautions

When the controller is removed from its sleeve, some of the exposed electronic components are vulnerable to damage by electrostatic discharge from someone handling the controller. To avoid this, before handling the unplugged controller discharge yourself to ground.

### Cleaning

Do not use water or water based products to clean labels or they will become illegible. Isopropyl alcohol may be used to clean labels. A mild soap solution may be used to clean other exterior surfaces of the product.



## INSTALLATION SAFETY REQUIREMENTS

### Safety Symbols

Various symbols are used on the instrument, they have the following meaning:



The functional earth connection is not required for safety purposes but to ground RFI filters.

### Personnel

Installation must only be carried out by qualified personnel.

### Enclosure of live parts

To prevent hands or metal tools touching parts that may be electrically live, the controller must be installed in an enclosure.

### Caution: Live sensors

The fixed digital inputs, non-isolated dc, logic and PDSIO outputs and the logic output of dual output modules, are all electrically connected to the main process variable input. If the temperature sensor is connected directly to an electrical heating element then these non-isolated inputs and outputs will also be live. The controller is designed to operate under these conditions. However you must ensure that this will not damage other equipment connected to these inputs and outputs and that service personnel do not touch connections to these i/o while they are live. With a live sensor, all cables, connectors and switches for connecting the sensor and non-isolated inputs and outputs must be mains rated.

### Wiring

It is important to connect the controller in accordance with the wiring data given in this handbook. Take particular care not to connect AC supplies to the low voltage sensor input or other low level inputs and outputs. Only use copper conductors for connections (except thermocouple inputs) and ensure that the wiring of installations comply with all local wiring regulations. For example in the in the UK use the latest version of the IEE wiring regulations, (BS7671). In the USA use NEC Class 1 wiring methods.

### Power Isolation

The installation must include a power isolating switch or circuit breaker. This device should be in close proximity to the controller, within easy reach of the operator and marked as the disconnecting device for the instrument.

### Earth leakage current

Due to RFI Filtering there is an earth leakage current of less than 0.5mA. This may affect the design of an installation of multiple controllers protected by Residual Current Device, (RCD) or Ground Fault Detector, (GFD) type circuit breakers.

### **Overcurrent protection**

To protect the internal PCB tracking within the controller against excess currents, the AC power supply to the controller and power outputs must be wired through the fuse or circuit breaker specified in the technical specification.

### **Voltage rating**

The maximum continuous voltage applied between any of the following terminals must not exceed 264Vac:

- line or neutral to any other connection;
- relay or triac output to logic, dc or sensor connections;
- any connection to ground.

The controller should not be wired to a three phase supply with an unearthed star connection. Under fault conditions such a supply could rise above 264Vac with respect to ground and the product would not be safe.

Voltage transients across the power supply connections, and between the power supply and ground, must not exceed 2.5kV. Where occasional voltage transients over 2.5kV are expected or measured, the power installation to both the instrument supply and load circuits should include a transient limiting device.

These units will typically include gas discharge tubes and metal oxide varistors that limit and control voltage transients on the supply line due to lightning strikes or inductive load switching. Devices are available in a range of energy ratings and should be selected to suit conditions at the installation.

### **Conductive pollution**

Electrically conductive pollution must be excluded from the cabinet in which the controller is mounted. For example, carbon dust is a form of electrically conductive pollution. To secure a suitable atmosphere in conditions of conductive pollution, fit an air filter to the air intake of the cabinet. Where condensation is likely, for example at low temperatures, include a thermostatically controlled heater in the cabinet.

### **Over-temperature protection**

When designing any control system it is essential to consider what will happen if any part of the system should fail. In temperature control applications the primary danger is that the heating will remain constantly on. Apart from spoiling the product, this could damage any process machinery being controlled, or even cause a fire.

Reasons why the heating might remain constantly on include:

- the temperature sensor becoming detached from the process;
- thermocouple wiring becoming short circuit;
- the controller failing with its heating output constantly on;
- an external valve or contactor sticking in the heating condition;
- the controller setpoint set too high.

Where damage or injury is possible, we recommend fitting a separate over-temperature protection unit, with an independent temperature sensor, which will isolate the heating circuit.

Please note that the alarm relays within the controller will not give protection under all failure conditions.

### **Grounding of the temperature sensor shield**

In some installations it is common practice to replace the temperature sensor while the controller is still powered up. Under these conditions, as additional protection against electric shock, we recommend that the shield of the temperature sensor is grounded. Do not rely on grounding through the framework of the machine.

## **INSTALLATION REQUIREMENTS FOR EMC**

To ensure compliance with the European EMC directive certain installation precautions are necessary as follows:

- For general guidance refer to Eurotherm Controls EMC Installation Guide, HA025464.
- When using relay or triac outputs it may be necessary to fit a filter suitable for suppressing the emissions. The filter requirements will depend on the type of load. For typical applications we recommend Schaffner FN321 or FN612.
- If the unit is used in table top equipment which is plugged into a standard power socket, then it is likely that compliance to the commercial and light industrial emissions standard is required. In this case to meet the conducted emissions requirement, a suitable mains filter should be installed. We recommend Schaffner types FN321 and FN612.

### **Routing of wires**

To minimise the pick-up of electrical noise, the wiring for low voltage dc and particularly the sensor input should be routed away from high-current power cables. Where it is impractical to do this, use shielded cables with the shield grounded at both ends.

## TECHNICAL SPECIFICATION

### Main Process Value Input and Second DC Input

Low level range	$\pm 100\text{mV}$
High level range	0 to 10Vdc or 0-20mA with external $2.49\Omega$ current shunt. All configurable between limits
Sample Rate	9Hz (110mS)
Resolution	$<2\mu\text{V}$ for low level range, $<0.2\text{mV}$ for high level range
Linearity	Better than $0.2^\circ\text{C}$
Calibration accuracy	The greater of 0.25% of reading or $\pm 1^\circ\text{C}$ or $\pm 1\text{LSD}$
User calibration	Low and high offsets can be applied
Input filter	Off to 999.9 secs
Thermocouple types	Refer to the ordering code sensor input table
Cold junction compensation	$>30$ to 1 rejection of ambient temperature changes in automatic mode. Uses INSTANT ACCURACY™ cold junction sensing technology to eliminate warm up drift and to respond quickly to ambient temperature changes.
RTD/PT100 input	External references 0, 45, and $50^\circ\text{C}$ 3-wire, Pt100 DIN43750. Bulb current 0.3mA. Up to $22\Omega$ in each lead without error
Potentiometer input	100 to 15Kohm
Analogue input functions	Process value, remote setpoint, setpoint trim, external power limit, feedforward input., valve position feedback
Second process value input functions	Select min, select max, derived value, transfer to 2 <sup>nd</sup> PV

### Digital inputs

Isolated except for fixed digital inputs 1 & 2	
Contact closure inputs	Open circuit voltage: 24 to 30 Vdc Short circuit current: 24 to 29mA Off state: $< 100$ ohms input resistance On state: $> 28\text{Kohm}$ input resistance
Logic inputs (current sinking)	Off state: -3 to 5Vdc @ $<-0.4\text{mA}$ On state: 10.8 to 30Vdc @ 2.5mA
Digital input functions	Refer to the ordering code

### Digital Outputs

Relay rating	Min: 12V, 100mAdc. Max:2A, 264Vac resistive
Single logic output	18Vdc, 20mA. This output is not isolated from the main process value input
Triple logic output	12Vdc, 8mA per channel (isolated)
Digital o/p functions	As per the ordering code
High current output	10Amp, 264Vac resistive. This option is not available on controller from Jan-04
Triac rating	1A, 30 to 264Vac resistive (isolated)

### Analogue outputs

Range	Scaleable between 0-20mA and 0-10Vdc (isolated)
Resolution	1 part in 10,000 for analogue retransmission
Analogue output functions	Refer to ordering code

**Transmitter supply**

Rating	20mA, 24Vdc
--------	-------------

**Control functions**

Control modes	On/Off, PID, or motorised valve control, with or without feedback potentiometer
Cooling algorithms	Linear, water (non-linear), fan (min on time), oil
Tuning	One shot (automatic tune of PID and overshoot inhibition parameters) and continuous adaptive tuning
Number of PID sets	Two
Auto/manual control	Bumpless transfer or forced manual output available
Setpoint rate limit	Display units per second, minutes or hour

**Alarms**

Number of alarms	Four
Alarm types	Absolute high or low. Deviation band, deviation high, deviation low. Rate of change
Alarm modes	Latching or non-latching. Blocking. Energised or de-energised in alarm

**Setpoint programming**

Number of programs	1, 4 or 20
Segments per program	16
Event outputs	Up to eight

**Communications** (all modules are isolated)

Profibus	High speed, RS485. Up to 1.5Mb/s
Modbus ®	RS232,2-wire,RS 485 and 4 wire RS485 modules
Baud rate	1200, 2400, 4800, 9600 and 19,200 baud

**PDS**

Slave input (isolated)	Remote setpoint input with holdback to master
Master output	Isolated from main PV. Retransmission of setpoint, process value or output

**General**

Display	Dual, 4 digit x 7 segment LED. Up to two decimal places
Supply	85 to 264Vac, 48 to 62 Hz, 10 W max OR 24Vdc or ac -15%, +20%. 10W max
Operating ambient	0 to 55°C and 5 to 90% RH non-condensing
Storage temperature	-10 to +70°C
Panel sealing	IP65
Dimensions	2408: 48mm wide x 96mm high x 150mm deep 2404: 96mm wide x 96mm high x 150mm deep
Weight	250g
EMC standards	EN61326-1 generic standards for industrial environments
Safety standards	Meets EN61010, installation category II (voltage transients must not exceed 2.5kV), pollution degree 2
Atmospheres	Not suitable for use above 2000m or in explosive or corrosive atmospheres. Electrically conductive pollution must be excluded from the cabinet in which this controller is mounted



## Appendix D LOAD CURRENT MONITORING AND DIAGNOSTICS

Current flowing in a system of electrical heating elements (the 'Load') can be displayed on the controller by using a Eurotherm TE10 SSR fitted with intelligent current transformer, PDCTX, or an SSR or contactor with an external PDCTX.

Load current monitoring and diagnostics may be used with any time proportioned output, fitted in module position 1A, and uses the logic output wires which drive the SSR to return signals back to the controller. These signals represent the RMS value of the load current during the ON period, or load related alarm conditions. It is not designed for analogue outputs i.e. phase angle control.

It is also designed for single phase operation only.

There are three modes of operation:-

### 1. Mode 1

Detects if there is a **break in the heater circuit**. This includes heater or SSR open circuit. A single **Load Failure** alarm message is displayed on the lower readout of the controller.

### 2. Mode 2

Provides the following:-

<b>Display of true RMS load current</b> On the lower readout of the controller	Displays the true RMS current in the ON state to the load.
<b>Low current alarm</b> Analogous to Partial Load Failure (PLF) supplied in some Eurotherm SSRs	Provides advanced warning of failure of one or more heaters in parallel
<b>High current alarm</b> Activated when the heater exceeds a set limit	Typically used where element bunching may occur
<b>SSR short circuit</b>	This will apply full power to the heaters which could result in an over temperature condition. This alarm provides early warning.
<b>Heater failure</b>	Indicates open circuit load conditions

### 3. Mode 5

Provides the same features as mode 2 with two additional alarms. This mode is for use with contactors or other devices which do not use the PDS logic output from the controller as the drive signal. For example, a time proportioning logic, relay or triac output to operate a contactor. Mode 5, therefore, requires an additional input to the controller to display the load conditions. It uses the LB digital input terminals for this, as shown in Figure D.2.

<b>Current Transformer Open Circuit</b>	Alarm is shown if the PDS connection to PDCTX or SSR become disconnected
<b>Current Transformer Short Circuit</b>	Alarm is shown if the PDS connection from PDCTX or SSR are short circuited



## EXAMPLE WIRING DIAGRAM (FOR MODE 1 & 2 OPERATION)

### Hardware Required

1. Eurotherm SSR type **TE10/PDS2** OR
2. Eurotherm intelligent current transformer type **PD/CTX** + **contactor or zero voltage switching SSR**

2408 or 2404 controller configured for PDS mode 2 option using logic output. This module must be fitted in module position 1. (order code **M2**).

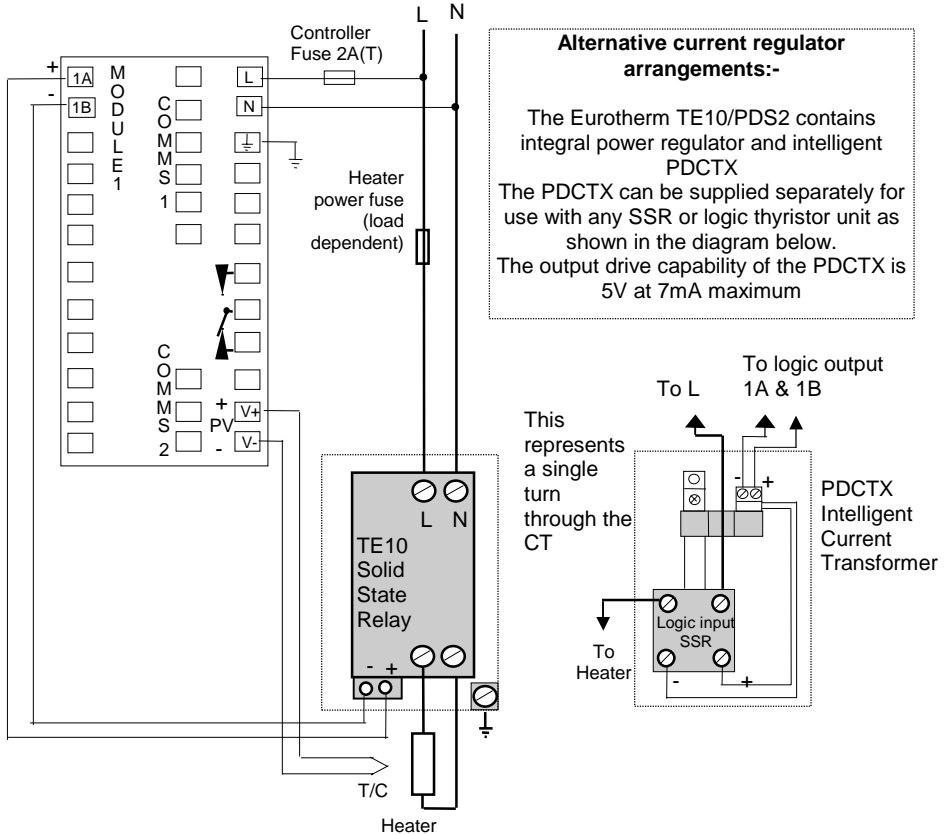

Figure D.1 Connections for Mode 1 & 2

### WARNING!

Take care that the controller is correctly wired for the mode of operation which is configured. Failure to do so may be hazardous in some situations.

## EXAMPLE WIRING DIAGRAM (FOR MODE 5 OPERATION)

### Hardware Required

1. Eurotherm intelligent current transformer type **PD/CTX + contactor**
2. 2408 or 2404 controller configured for PDS mode 5 option using logic, relay or triac output. This module must be fitted in module position 1. Digital input LB (order code M5) must be configured to accept PDCTX input as described in the configuration section of this appendix.

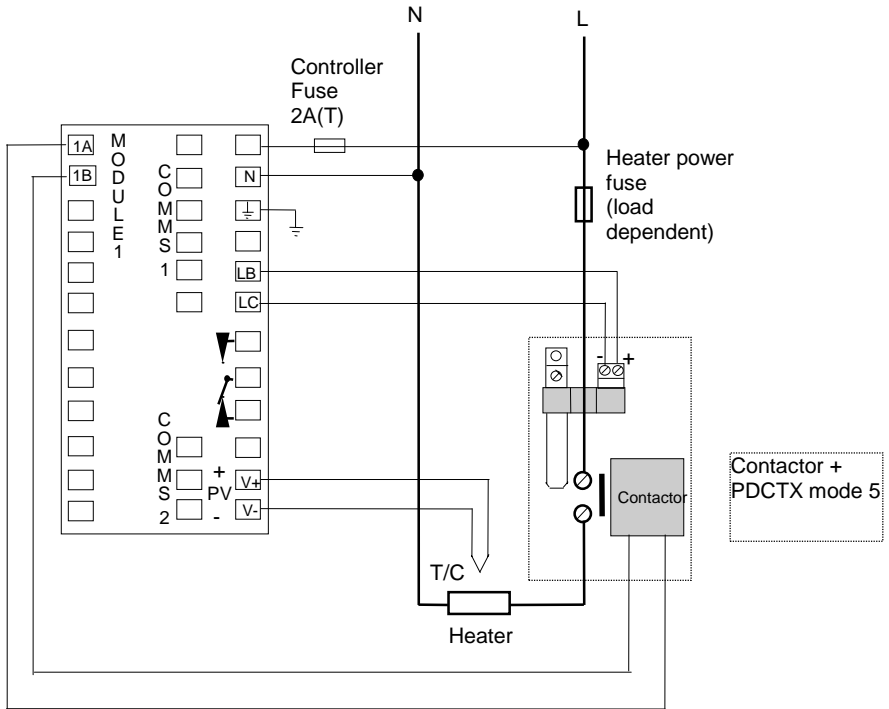

The controller will have the order code M5 in the Logic Input position.



**Figure D.2 Example Wiring Connections For Contactor Operation (mode 5)**

### WARNING!





**Take care that the controller is correctly wired for the mode of operation which is configured. Failure to do so may be hazardous in some situations.**

## OPERATION

### To Read Load Current (modes 2 and 5 only)

Do This	This Is The Display You Should See	Additional Notes
<p>From the 'nFO' list</p> <p>Press  until <i>AmPS</i> is shown in the upper display</p>	 <p>Current will be displayed in the lower readout. See also 'Display Modes' below.</p>	<p>It will revert to the HOME display after 45 seconds or 10 seconds if an alarm is present</p>
	 <p>This display will be shown if:</p> <ol style="list-style-type: none"> <li>I. The controller is unable to resolve the reading</li> <li>II. The controller is obtaining a reading</li> <li>III. The measurement has timed out i.e. current has not flowed for 15 seconds, in mode 2.</li> </ol>	

### To Display Load Current Continuously in the Lower Readout (modes 2 and 5 only)

Do This	This Is The Display You Should See	Additional Notes
<p>From the 'HOME' display, Figure 1.4,</p> <p>Press  until <i>d, SP</i> is shown in the upper display</p> <p>Press  or  until <i>AmPS</i> is displayed in the lower display</p>		<p>Current will be displayed in the lower readout continuously when the controller reverts to the HOME display, see also 'Display Modes' below.</p>

## Display Modes

### SSR RMS On State Current

This is the default state when high or low current alarms are configured. The load current displayed is the steady state true rms current measured during the ON period.

The minimum on times are:-

Mode 2	0.1second
Mode 5	3 seconds

### Meter Mode

Meter mode applies to mode 5 only. If low current alarms are **not** configured the current displayed is a filtered instantaneous RMS value. This behaves like a damped analogue meter. It may be used in applications where the current sensor is not linked to control, for example, telemetry, indication.



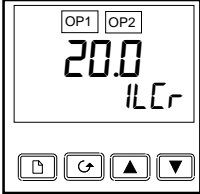

### How Heater Alarms Are Displayed

Do This	This Is The Display You Should See	Additional Notes
<p>If an alarm is present it will flash a four character mnemonic in the lower display</p>	<p>Actual Temperature (PV) →</p>  <p>The image shows a digital display with 'HOME Display' at the top. Below it are two small boxes labeled 'OP1' and 'OP2'. The main display area shows '20.0' in large digits and 'ILLr' in smaller digits below it. At the bottom of the display are four navigation buttons: a square with a diagonal line, a square with a circular arrow, a square with an upward-pointing triangle, and a square with a downward-pointing triangle. An arrow points from the text 'Actual Temperature (PV)' to the '20.0' value.</p>	<p>If more than one alarm is active, the display will alternate between the alarm messages and the default parameter in the lower display</p>

**The Alarm Messages are:-**

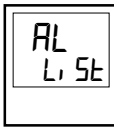

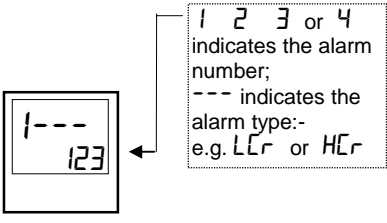

Mnemonic	Meaning	Description
<p>The following two messages are alarms which are produced as a result of failure within the process. In place of dashes the alarm number will appear i.e 1, 2, 3, or 4</p>		
-L <u>L</u> r	Alarm number - <u>Low</u> <u>C</u> urrent	Used for partial load failure detection. To avoid nuisance tripping due to supply voltage variations set to a value at least 15% below the minimum normal operating current
-H <u>L</u> r	Alarm number - <u>High</u> <u>C</u> urrent	Used for load overcurrent protection. To avoid nuisance tripping due to supply voltage variations set to a value at least 15% above the maximum normal operating current. <b>Note: This alarm is not intended to provide instantaneous safety protection from short circuit fault conditions</b>
<p>The following message is a diagnostic alarm which appears for mode 1 operation only.</p>		
L <u>d</u> F	<u>L</u> oad <u>F</u> ail	This includes failure of the heater circuit or the SSR
<p>The following four messages are diagnostic alarms produced as a result of failure within the equipment or wiring connections. They appear for modes 2 and 5 operation only. They may be enabled using the <u>d</u>i <u>AL</u> parameter in the <u>AL</u> <u>L</u>i <u>S</u>et, see 'SHORT CIRCUIT SSR ALARM AND HEATER FAIL ALARM'</p>		
H <u>t</u> r F	<u>H</u> ea <u>t</u> er <u>F</u> ail	No current is being drawn while the controller output demand signal is on
S <u>S</u> r F	<u>S</u> SR <u>F</u> ail	The load is continuously on while the controller output demand signal is off
C <u>t</u> OP	<u>C</u> urrent <u>T</u> ransformer <u>O</u> pen <u>C</u> ircuit	Indicates that the PDS input is open circuit. Mode 5 only
C <u>t</u> Sh	<u>C</u> urrent <u>T</u> ransformer <u>S</u> hort <u>C</u> ircuit	Indicates that the PDS input is short circuit Mode 5 only

## TO SET THE ALARM TRIP LEVELS

Do This	This Is The Display You Should See	Additional Notes
From the HOME display press  until the <b>AL L, St</b> is displayed		To select the Alarm List header
Press  button until the desired alarm number is displayed  Press  or  to adjust the alarm trip level	 1 2 3 or 4 indicates the alarm number; --- indicates the alarm type:- e.g. LCr or HCr	To select the diagnostic alarm parameter found under the Alarm List header  The alarm trip level is set to 123

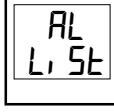
## SHORT CIRCUIT SSR ALARM AND HEATER FAIL ALARM

These alarms exist as **Diagnostic Alarms** in the controller. To make the alarm active it is only necessary to turn on the diagnostic alarm feature in the Alarm List in the Operator Level

Do This	This Is The Display You Should See	Reason
From the HOME display press  button until the <b>AL L, St</b> is displayed		This opens the list which contains the <b>d, AG</b> mnemonic
Press  until <b>d, AG</b> is displayed  Press  or  to select <b>YES</b>		This activates the <b>d, AG</b> mnemonic to allow Diagnostic Alarms to be displayed in the lower readout of the HOME display

## RELAY OUTPUTS

The fixed relay output connected to terminals AA to AC in a 1/8 or 1/4 DIN controller is normally used for alarm purposes. In addition, any plug in module can be used for alarms provided they are not already being used for another purpose, such as control. Any one or more alarms can be attached to an output, which will operate when an alarm occurs. Contacts are rated at 2A 264Vac for operating external beacons or audible devices.











## TO CONFIGURE PDS LOAD CURRENT DIAGNOSTICS

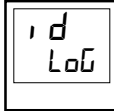















Configuration of PDS load current diagnostics is in four parts:-

1. Configure the Logic Module for PDS Mode 1 or 2 operation. If the control device is a contactor or standard SSR, configure the LA digital input for mode 5 operation.
2. Configure the Low and High Current trip alarms.
3. Attach the alarms to operate an output relay.
4. Set up the Scaling Factor.









**First enter Configuration Level.** See Chapter 5

## TO CONFIGURE THE LOGIC MODULE FOR PDS MODES 1 OR 2

Do This	This Is The Display You Should See	Additional Notes
Press  until the <b>1A Conf</b> is displayed		This opens the configuration list associated with module position 1A
Press  to show <b>1d</b>		This shows the identity of the module  The module identity is <u>logic</u> output
Press  to show <b>Func</b>  Press  or  to show <b>SSr 1</b> or <b>SSr 2</b> as required.		This shows the <u>function</u> of module  The module function is set to PDS mode 1
Press  to show <b>UALL</b>  Press  or  to show <b>00</b>		This is the lower PID demand level  To set the minimum PID signal to 0%

<p>Press  to show UPLH)</p> <p>Press  or  to show 100.0</p>		<p>This is the upper PID demand level</p> <p>To set the maximum PID signal to 100%</p>
<p>Press  to show OUEL</p> <p>Press  or  to show 0.0</p>	 <p><b>Warning!</b> If OUEL is set to any figure other than 0 the minimum output power will be limited to this level. You must ensure that this does not present an unsafe condition for</p>	<p>This is the minimum output power</p> <p>To set the min output power to 0</p>
<p>Press  to show OUEH</p> <p>Press  or  to show 100.0</p>		<p>This is the maximum output power</p> <p>To set the max output power to 100</p>
<p>Press  to show SEnS</p> <p>Press  or  to show nOr</p>		<p>This sets the output signal to normal for heating control</p>

### TO CONFIGURE LOGIC INPUT B FOR PDS (MODE 5 ONLY)

Do This	This Is The Display You Should See	Additional Notes
Press  button until the <i>Lb Conf</i> is displayed		
Press  to show <i>ld</i>		This identifies the LA input as logic and is read only
Press  to show <i>Func</i> Press  or  to select <i>AmPS</i>		To configure the input for the PDCTX.











The system is designed to operate in either mode 2 or mode 5 configuration only. Selecting both simultaneously will disable the output. However, mode 1 and mode 5 can be used together.



### TO CONFIGURE LOW AND HIGH CURRENT TRIP ALARMS

Alarm 1 will be configured as Load Current Low (LCr)





Alarm 2 will be configured as Load Current High (HCr)

Do This	This Is The Display You Should See	Additional Notes
Press  button until the <b>AL Conf</b> is displayed		This opens the configuration list which contains the Alarms
Press  to show <b>AL 1</b> (alarm 1)  Press  or  to show <b>LCr</b>	 <p>After 0.5 sec the display will blink to show the alarm type has been accepted</p>	To select alarm 1  To make alarm 1 = <u>L</u> ow <u>C</u> urrent
Press  until <b>AL 2</b> (alarm 2) appears  Press  or  to show <b>HCr</b>	 <p>After 0.5 sec the display will blink to show the alarm type has been accepted</p>	To select alarm 2.  To make alarm 2 = <u>H</u> igh <u>C</u> urrent

**Note:-** The above alarms are known as **SOFT ALARMS** because they are indication only.

## TO ATTACH SOFT ALARMS TO A RELAY OUTPUT

Any one alarm indicated above may be attached to an output (normally a relay). Alternatively any combination of alarms may be attached to operate a relay using the procedure below:-

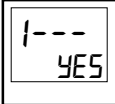
Do This	This Is The Display You Should See	Additional Notes
<p>Press "PAGE" key  as many times as necessary to <b>AA Conf</b></p>		<p>To select the output which you want to operate when the alarm condition occurs. You may also choose 1A, 1B, 1C, 2A, 2B, 2C, 3A, 3B, 3C or 4A depending upon the controller and the number and type of modules fitted</p>
<p>Press  until <b>1---</b> is displayed</p> <p>Press  or  to select <b>YES</b> or</p> <p>Repeat the above step for every alarm to be attached to the output</p>	 <p><b>1---</b> denotes alarm 1 followed by three letters which denote the alarm type e.g. <b>LEF</b></p>	<p><b>YES</b> means that the selected output will activate when an alarm occurs in normal operation <b>no</b> means the output will not activate</p>

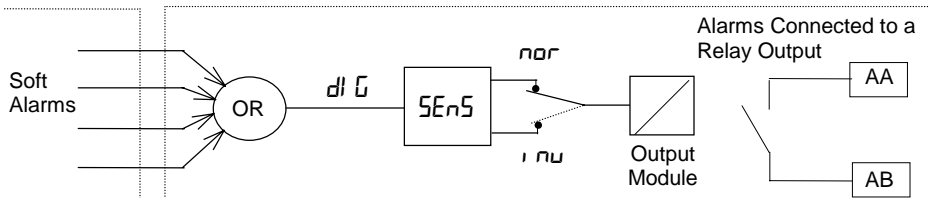







## THE SCALING FACTOR

The value of the current displayed on the controller is scaled using the scaling factor. This is found in the **1 nSt Conf** list. It is set, by default, to 100 and assumes a single turn through the current transformer. If two turns are made through the current transformer it will be necessary to adjust the scaling factor to 50 to obtain the same reading.

Under normal conditions you should not need to change the scaling factor.

If, however, you wish to change the sensitivity of the current reading, for example, to read very low currents you may need to change the number of turns through the PDCTX and/or adjust the scaling factor to compensate. See also note 1 below.

## TO ADJUST THE SCALING FACTOR

Do This	This Is The Display You Should See	Additional Notes
Press  button until <b>1 nSt Conf</b> is displayed		
Press  until <b>LCHi</b> is displayed		
Press  or  to change the scaling factor		

### Note 1:-

#### Minimum Resolvable Current

TE10 4A RMS. It is not possible to read currents lower than 4A when using a TE10.

PDCTX 4A RMS for a single turn through the PDCTX

Should you wish to read currents lower than 4A using a PDCTX it is necessary to increase the number of turns through the PDCTX and adjust the scaling factor to compensate.

For example: To read 1.0A wind 4 turns through the PDCTX and adjust the scaling factor to 25 as shown in the table below.

Scalar = 100/N Where N = Turns through PDCTX			
N	Scalar	N	Scalar
1	100	5	20
2	50	10	10
4	25		

#### Maximum Resolvable Current

TE10 Determined by the maximum range of the SSR

PDCTX 100A (or 100 ampere turns)

**Finally Exit configuration level.** See Chapter 5.

## Appendix E: Profibus Communications

### Introduction

The 2408*f* and 2404*f* are special versions of the 2408 and 2404 controllers designed for Profibus-DP communications. The 'standard' 2408 or 2404 controllers cannot be upgraded to a 2408*f* or 2404*f* as the latter uses a different version of the microprocessor board.

Profibus-DP is available with either the 85 to 264Vac or 20-29Vac/dc supply

Apart from the restrictions listed below, the operation, functions and wiring of the 2404*f* and 2408*f* are identical to that of the standard 2408 and 2404 controllers.

- Modbus communications may be configured to replace Profibus-DP if required.
- This must be installed in module slot H.
- EI Bisynd protocol is not supported, therefore the IPSP instrument programming system cannot be used.
- The 20 programmer option is not available.
- The PDSIO input and output modules can only be installed in module slot J.

### About Profibus-DP

Profibus-DP is an industry standard, open network used to connect simple devices in a machine or manufacturing plant. It is most often used to allow a central Programmable Logic Controller or PC based control system to use external 'slave' devices for I/O or specialised functions. One advantage is that these devices may be distributed around a machine, saving on the cost of point to point wiring. The 'open' nature of the network permits equipment from different manufacturers to be mixed easily so that best of breed equipment may be used. Additionally, the off-loading of specialised tasks such as PID temperature control lessens the processing load on the central PLC so that its other functions may be carried out more efficiently.

Profibus-DP is described in DIN 19245 Part 3, and is part of EN 50170.

The Profibus-DP network uses a high speed version of the RS485 standard, permitting baud rates of up to 12Mbaud. The 2408*f* and the 2404*f* support rates of up to 1.5 Mbaud in order to meet electrical isolation standards. A table of network speed against line length is given in the section on wiring below.

Up to 32 Profibus stations (nodes) may be wired to a single network segment. Use of RS485 repeaters allows a total of up to 127 stations.

Other variants of Profibus that exist are Profibus FMS, which is designed to allow higher level communication such as that between PLCs and SCADA systems, and Profibus PA, which has an optional low speed, intrinsically safe, physical medium and is designed for use in the Process Industry. The 2408*f* and 2404*f* controllers can be used on a combined DP and FMS network, sharing the same physical medium, but may only be used for PA when the intrinsically safe physical medium is not used.

Profibus-DP is a multimaster, master-slave, token passing network. The 2408f and the 2404f operate as intelligent slave units. More detailed information, including a detailed guide to products available, may be obtained from the various world wide Profibus user organisations. You will find contact information in trade magazines or by reference to <http://www.profibus.com> on the World Wide Web.

### Technical Specification

Physical Medium	2-wire RS485
Network topology	Linear bus with active termination of the bus at both ends Stub lines permitted if < 6.6m in length
Protocol	Profibus-DP, intelligent slave
Baud rate	Up to 1.5Mb/s
Number of stations	32 per network segment. Up to 127 with repeaters

### Electrical Connections

The diagram below is also shown in Chapter 1.

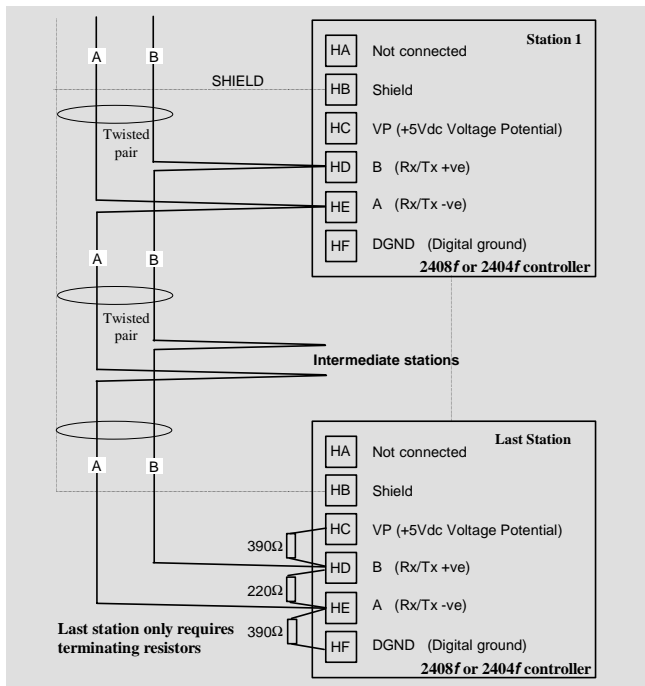

### Cable Specifications

Either of the two cable types detailed below can be used. Please note that the cable types A and B, specified below, are NOT related to the wire numbers A and B in the above wiring diagram. Type A is recommended as it allows higher speed and longer cable length.

	Type A cable	Type B cable
Characteristic Impedance:	135 to 165Ω at a frequency of 3 to 20 MHz.	135 to 165Ω at a frequency of > 100 kHz
Cable capacitance:	< 30 pF per Metre	typ. < 60 pF per Metre
Core diameter:	max. 0.34 mm <sup>2</sup> , corresponds to AWG 22	max. 0.22 mm <sup>2</sup> , corresponds to AWG 24
Cable type:	twisted pair cable. 1x2 or 2x2 or 1x4 lines	twisted pair cable. 1x2 or 2x2 or 1x4 lines
Resistance:	< 110 Ohm per km	-
Shielding:	Copper shielding braid or shielding braid and shielding foil	Copper shielding braid or shielding braid and shielding foil

### Maximum Line Length per Segment

Baud rate (kbit/sec)	9.6	19.2	93.75	187.5	500	1500
Type A cable	1200m	1200m	1200m	1000m	400m	200m
Type B cable	1200m	1200m	1200m	600m	200m	-

Belden B3079A meets cable A specifications, but there are other choices. For more information refer to the 'Profibus Product Guide' produced by the Profibus User Group.

## Controller Configuration and Node Address

Having connected the controller to the network, it must be configured for Profibus communications and a node address assigned.

### Configuration

In the *HA* list set *Func = Prof*.



#### Comms configuration list - HA

Refer to the main handbook for instructions on how to select configuration level and access the *HA* list



#### Identity of module

This should be a read-only parameter displaying *cmS*



#### Function

Set *Func = Prof* to select Profibus protocol



#### Resolution *FULL* = Full, *INT* = Integer

This is the only other parameter that appears in this list when *Prof* is selected as the function.

Note: The baud rate is automatically selected by the master.

### Assigning a Node Address

Refer to the main handbook for instructions on how to select and change parameters.

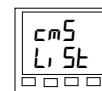



#### Comms list

From the HOME display, press  until you reach the *cmS* list



#### Node address

Press  to display the node address. Press  or  to set the desired address. 0 - 125



#### Comms Status

This is a read-only diagnostic display

*rdy* Ready to run

*run* Comms running

## Network configuration

Having wired and configured the controller, the PLC or PC based supervisory package must be configured to set-up the parameters that it will be able to read and write to. This is known as 'network configuration'

The network is configured by importing 'GSD' files into your Master Profibus network configuration software: Refer to the network configuration software documentation for details. 'GSD' is an acronym of a German phrase meaning 'Device Database'.

GSD files for the 2408f and 2404f controllers are created using a Windows based configuration tool. This is separately supplied under ordering code PROF-ENG. A Communications Handbook (part number HA026290ENG), supplied with the configurator, gives all the required information

Two standard GSD files, are supplied on the disc:

EURO2400.GSD	standard parameter mapping
EURD2400.GSD	standard parameter mapping with 'demand data', which allows random read/write to any parameter within the controller.

It is possible to edit the above files or create new files using the Windows configurator. Details are given in the communications handbook.

The Master network configuration software uses the GSD files to produce a further file which is downloaded into your master PLC or PC supervisory package. Once the configuration file has been downloaded, you can set the network running. If all is well, the 'REM' beacon on the controller will start to flash, indicating that the data exchange is proceeding. The **START** parameter in the **CM5** list will show **RUN**. You may then write to Profibus outputs, and read from Profibus inputs as required by your control strategy.

In case of problems, a troubleshooting section is provided on the next page.

### Windows configurator

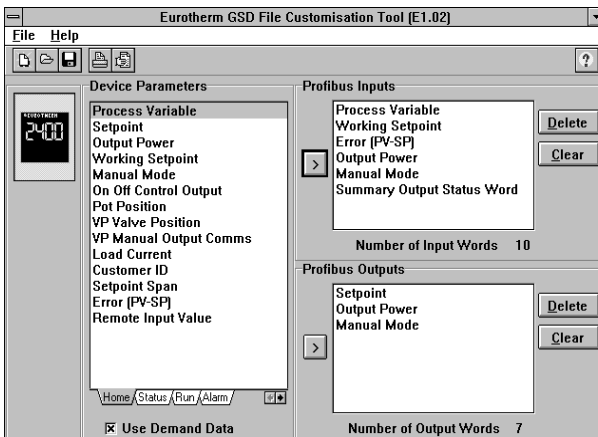

#### What does it do?

It creates a 'GSD' file which defines the inputs and outputs that the PLC or supervisory package will be able to talk to. The GSD file is imported into a Profibus Master configuration tool which in-turn produces a file that is downloaded into the PLC or supervisory package.

#### How do I use it?

Click on the tabs at the bottom of the device parameter window to select a parameter page. Then use the mouse to drag a required parameters into either the Profibus input or output lists.

#### How many parameters can I select?

Up to 117 per node, total of inputs and outputs.

#### What can I run it on?

Windows 3.1, Windows 95, or Windows NT.



## Troubleshooting

### No Communications:

- Check the wiring carefully, paying particular attention to the continuity of the A and B connections to the Master. Ensure that the correct terminals have been wired to.
- Access the *HA* list in configuration level and check that the function (*Func*) is set to *Prof*. If not, the controller is not configured for Profibus.
- Check that the Node Address (*Addr*) in the *cm5* list is correct for the network configuration in use.
- Ensure that a Profibus Comms Module is installed in slot H of the 2404/8f. It can be identified by of the legend on the plug-in module casing, and its distinctive shape:

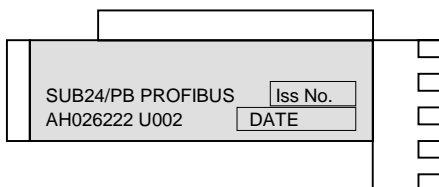

- Ensure that the network is correctly configured and the configuration has been transmitted correctly to the Profibus master.
- Verify the GSD file in use is correct by loading it into the master GSD Configuration tool. This will check the format.
- Verify that the maximum line length for the baud rate in use is not exceeded (see table above). Note that the 2404/8f is restricted to use at a maximum rate of 1.5 Mbaud.
- Ensure that the last device (not necessarily a 2404/8f) in the network segment is correctly terminated (see wiring diagram).
- Ensure that no devices other than those at the end of a segment have termination networks fitted.
- If possible, replace faulty device with a duplicate and retest.

### Intermittent failure to communicate.

#### Intermittent flickering of status from *rdy* to *run*.

#### Diagnostic status changing but no alarms present in the controller.

- Verify wiring, paying particular attention to screening.
- The I/O data length may be too long. Some Profibus DP Master implementations can accept no more than 32 input and 32 output words per slave device. Verify by reference to documentation of the Master.
- Verify that the maximum line length for the baud rate in use is not exceeded (see cable specifications). Note that the 2404/8f is restricted to use at a maximum rate of 1.5 Mbaud.
- Ensure that the last device (not necessarily a 2404/8) in the network segment is correctly terminated (see wiring diagram).
- Ensure that no devices other than those at the end of a segment have termination networks fitted.
- Verify operation with a duplicate device if possible.

## INTERNATIONAL SALES AND SERVICE

**AUSTRALIA** Sydney  
Eurotherm Pty. Ltd.  
Telephone (+61 2) 9838 0099  
Fax (+61 2) 98389288

**AUSTRIA** Vienna  
Eurotherm GmbH  
Telephone (+43 1) 7987601  
Fax (+43 1) 7987605

**BELGIUM** Moha &  
**LUXEMBURG** Huy  
Eurotherm S.A./N.V.  
Telephone (+32 1) 85 274080  
Fax (+32 1) 85 274081

**BRAZIL** Campinas-SP  
Eurotherm Ltda.  
Telephone (+55 19) 3237 3413  
Fax (+55 19) 3234 7050

**DENMARK** Copenhagen  
Eurotherm Danmark A/S  
Telephone (+45 70) 234670  
Fax (+45 70) 234660

**FINLAND** ABO  
Eurotherm Finland  
Telephone (+358) 22506030  
Fax (+358) 22503201

**FRANCE** Lyon  
Eurotherm Automation SA  
Telephone (+33 478) 664500  
Fax (+33 478) 352490

**GERMANY** Limburg  
Eurotherm Deutschland GmbH  
Telephone (+49 6431) 2980  
Fax (+49 6431) 298119  
Also regional offices

**HONG KONG** Aberdeen  
Eurotherm Limited  
Telephone (+852) 28733826  
Fax (+852) 28700148

**INDIA** Chennai  
Eurotherm India Limited  
Telephone (+9144) 24961196  
Fax (+9144) 2256682070

**IRELAND** Dublin  
Eurotherm Ireland Limited  
Telephone (+353 01) 4691800  
Fax (+353 01) 4691300

**ITALY** Como  
Eurotherm S.r.l.  
Telephone (+39 031) 975111  
Fax (+39 031) 977512

**KOREA** Seoul  
Eurotherm Korea Limited  
Telephone (+82 31) 2738507  
Fax (+82 31) 2738508

**NETHERLANDS** Alphen a/d Ryn  
Eurotherm B.V.  
Telephone (+31 172) 411752  
Fax (+31 172) 417260

**NORWAY** Oslo  
Eurotherm A/S  
Telephone (+47 67) 592170  
Fax (+47 67) 118301

**SPAIN** Madrid  
Eurotherm España SA  
Telephone (+34 91) 6616001  
Fax (+34 91) 6619093

**SWEDEN** Malmo  
Eurotherm AB  
Telephone (+46 40) 384500  
Fax (+46 40) 384545

**SWITZERLAND** Freienbach  
Eurotherm Produkte (Schweiz) AG  
Telephone (+41 55) 4154400  
Fax (+41 55) 4154415

**UNITED KINGDOM** Worthing  
Eurotherm Limited  
CONTROLS &  
DATA MANAGEMENT  
Telephone (+44 1903) 695888  
Fax (+44 1903) 695666  
PROCESS AUTOMATION  
Telephone (+44 1903) 205277  
Fax (+44 1903) 236465

**U.S.A** Leesburg  
Eurotherm Inc.  
Telephone (+1 703) 443 0000  
Fax (+1 703) 669 1300  
Web [www.eurotherm.com](http://www.eurotherm.com)

ED 38

<http://www.eurotherm.co.uk>



© Copyright Eurotherm Limited 2004

All rights are strictly reserved. No part of this document may be reproduced, modified, or transmitted in any form by any means, nor may it be stored in a retrieval system other than for the purpose to act as an aid in operating the equipment to which the document relates, without the prior written permission of Eurotherm limited.

Eurotherm Limited pursues a policy of continuous development and product improvement. The specifications in this document may therefore be changed without notice. The information in this document is given in good faith, but is intended for guidance only. Eurotherm Limited will accept no responsibility for any losses arising from errors in this document.



HA025132